

# ESD Electrostatic Protection Device Catalog 2023

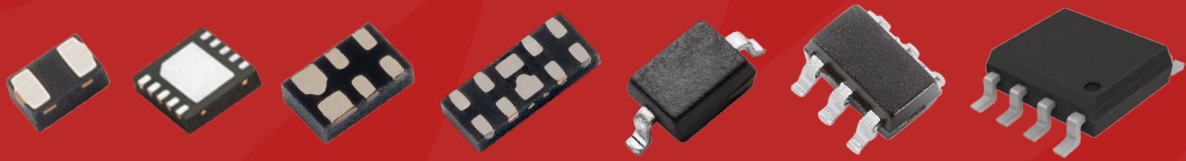

# CATALOGUE

## Semiware Semiconductor Inc.

No.3387 Shendu Road Pujiang  
I&E Park Shanghai China  
201000

### Free Hotline:

400-021-5756

### Sales:

86-21-3463-7458  
Sales01@semiware.com

### Technical Support:

86-21-3463-7654  
Fae01@semiware.com



For more product information,  
Please scan the QR code or visit our  
website:

<https://semiware.com/products/ESD-Protection-Diodes>

## INDUSTRY & CONSUMER ▼

DFN0603	P1-2
SOD-923	P3
DFN1006	P4-6
DFN1006P3	P7
DFN1109MP6	P8
DFN1610P6	P9-10
SOD-523	P11-14
DFN1610	P15-16
DFN2020-3L	P17-18
DFN1510TP6	P19
SOT-553	P20
SOT-523	P21
DFN2010P5	P22
SOT-323	P23
DFN2010P8	P24
SOT-363	P25
SOT-353	P26
DFN2510P10	P27-29
SOD-323	P30-33
SOT-143	P34-35
SOT-23	P36-37
SOT-23-6	P38
SOT-23-5	P39-40
SOD-123	P41
SOP-8	P42

## AUTOMOTIVE ▼

DFN0603	P43
DFN1610P6	P44-45
DFN1006	P46-47
SOD-523	P48
DFN2510P10	P49-50
SOT-363	P51
SOT-323	P52
SOD-323	P53-54
SOT-23-5	P55
SOT-23-6	P56
SOT-23	P57-58

To find your local partner within Semiware's global network: [www.semiware.com](http://www.semiware.com)

© 2022 Semiware Semiconductor Inc.

The content of this document has been carefully checked and understood. However, neither Semiware nor its subsidiaries assume any liability whatsoever for any errors or inaccuracies of this document and the consequences thereof. Published specifications are subject to change without notice. Product suitability for any area of application must ultimately be determined by the customer. In all cases, products must never be operated outside their published specifications. Semiware does not guarantee the availability of all published products. This disclaimer shall be governed by substantive Swiss law and resulting disputes shall be settled by the courts at the place of business of Semiware. Latest publications and a complete disclaimer can be downloaded from the Semiware website. All trademarks recognized.

## DFN0603 PACKAGE INFORMATION

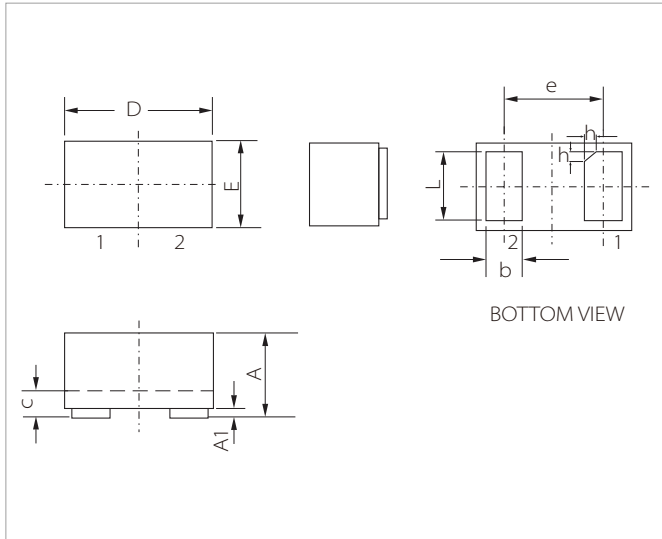





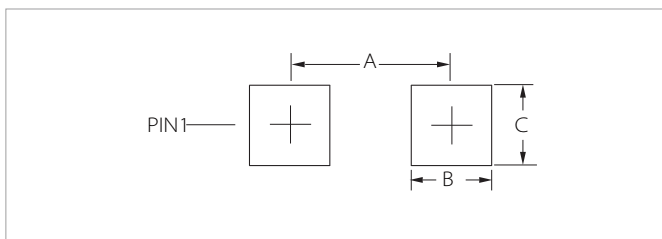





Ref.	Millimeters		Inches	
	Min.	Max.	Min.	Max.
A	0.28	0.34	0.011	0.014
A1	0	0.05	0	0.002
b	0.13	0.24	0.005	0.009
c	0.05	0.15	0.002	0.006
D	0.55	0.65	0.022	0.026
e	0.35BSC		0.014BSC	
E	0.25	0.35	0.010	0.014
L	0.20	0.30	0.008	0.012
h	0	0.10	0	0.004

## RECOMMENDED PAD LAYOUT DIMENSIONS



Ref.	Millimeters	Inches
A	0.38	0.015
B	0.23	0.009
C	0.30	0.012

Part Number	Schematic Symbol	Polar	Device Marking Code	Reverse Stand-off Voltage	Reverse Leakage Current	Clamping Voltage (Tp=8/20us)	Peak Pulse Current (Tp=8/20us)	Off State Junction Capacitance
			$V_{RWM} (V)$	$V_{BR} (V)$	$I_R (\mu A)$	$V_C (V)$	$I_{PP} (A)$	$C_j (pF)$
SE5D50B5.0A		Bi	5	6	0.5	15	35	140
SE06F08B3.3A		Bi	3.3	4	0.5	8	10	18
SE06F10B3.3A		Bi	3.3	3.5	1	10	9	15
SE06F10B3.3MA		Bi	3.3	4.2	0.1	22	4	0.28
SE06F10B3.3MA-SP		Bi	3.3	2/3.3	5/200	5.8	6	0.32

Part Number	Schematic Symbol	Polar	Device Marking Code	Reverse Stand-off Voltage	Reverse Leakage Current	Clamping Voltage (Tp=8/20us)	Peak Pulse Current (Tp=8/20us)	Off State Junction Capacitance
			$V_{RWM}$ (V)	$V_{BR}$ (V)	$I_R$ (uA)	$V_C$ (V)	$I_{pp}$ (A)	$C_j$ (pF)
SE06F10B5.0A		Bi	5	5.6	0.5	1	5.5	15
SE06F10B5.0MA		Bi	5	6	0.1	25	4	0.6
SE06F10B5.0UA		Bi	5	6	0.2	22	4	0.5
SE06F10B10LA		Bi	10	12	1	24.5	1.65	1.8
SE06F10B12LA		Bi	12	13.3	0.5	25	6	5
SE06F10B18LA		Bi	18	21	1	50	1	2.5
SE06F10B24LA		Bi	24	27.2	1	50	1	2.5
SE06F10B5.0MA		Bi	5	6	0.2	22	4	0.22
SE06F10B5.0UA		Bi	5	6	0.2	22	4	0.22
SE06F10B10LA		Bi	10	12	1	24.5	1.65	1.8
SE06F10B12LA		Bi	12	13.3	0.5	25	6	5

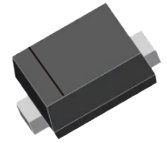

## SOD-923 PACKAGE INFORMATION

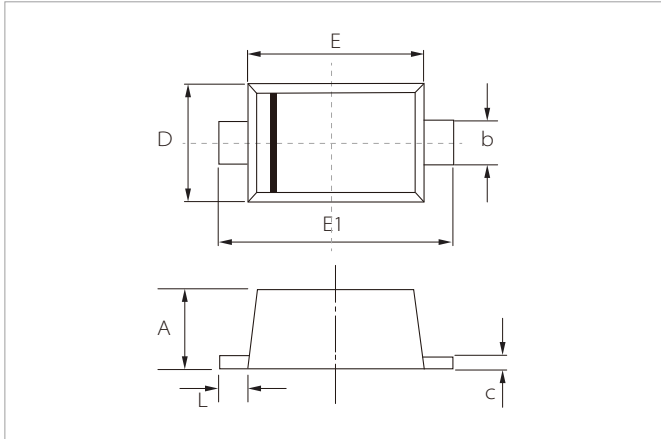





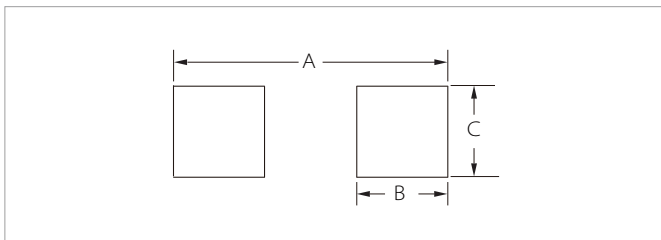

Ref.	Millimeters		Inches	
	Min.	Max.	Min.	Max.
A	0.34	0.45	0.013	0.002
b	0.15	0.3	0.006	0.012
c	0.07	0.15	0.003	0.006
D	0.55	0.65	0.022	0.026
E	0.70	0.90	0.028	0.036
E1	0.90	1.10	0.036	0.044
L	0.05	0.15	0.002	0.006

## RECOMMENDED PAD LAYOUT DIMENSIONS



Ref.	Millimeters	Inches
A	1.10	0.043
B	0.30	0.012
C	0.40	0.016

Part Number	Schematic Symbol	Polar	Device Marking Code	Reverse Stand-off Voltage	Reverse Leakage Current	Clamping Voltage (Tp=8/20us)	Peak Pulse Current (Tp=8/20us)	Off State Junction Capacitance
			$V_{RWM}$ (V)	$V_{BR}$ (V)	$I_R$ (uA)	$V_C$ (V)	$I_{pp}$ (A)	$C_j$ (pF)
SE9D10U5.0A		Uni	5	6.2	1	12.3	7.5	40
SE9D10B5.0MA		Bi	5	6.5	10/100	15	2	0.8
SE9D10U5.0UA		Uni	5	5.4	1	9.8	1	0.9
SE9D15B5.0A		Bi	5	5.6	1	11	5	13
SE9D15U12A		Uni	12	13.5	1	23.7	5.9	30
SE9D20B5.0A		Bi	5	5.6	0.5	20	10	15
SE9D15B5.0A		Bi	5	5.6	1	11	5	13

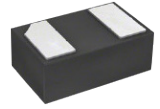

## DFN1006 PACKAGE INFORMATION

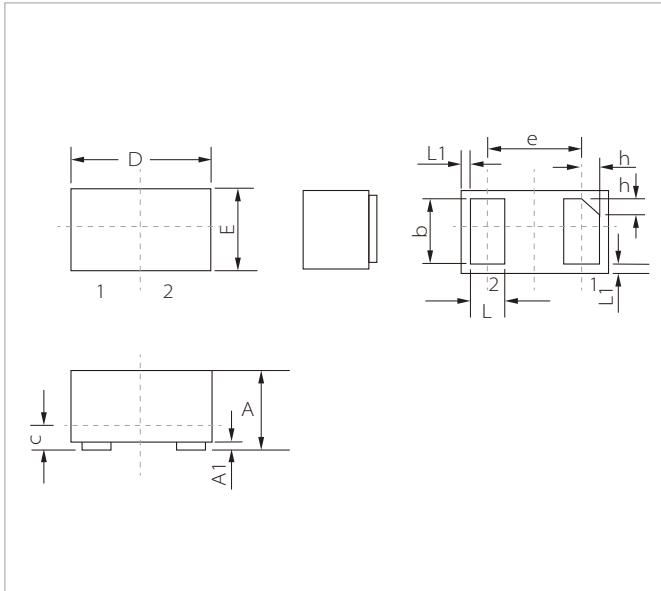





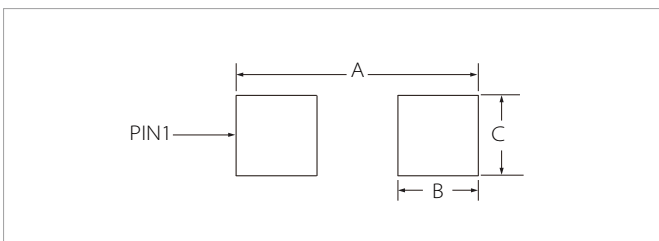















Ref.	Millimeters		Inches	
	Min.	Max.	Min.	Max.
A	0.35	0.50	0.014	0.020
A1	0	0.05	0	0.002
b	0.40	0.55	0.016	0.022
c	0.12	0.18	0.005	0.007
D	0.95	1.05	0.037	0.041
e	0.65BSC		0.026BSC	
E	0.55	0.70	0.022	0.027
L	0.20	0.35	0.008	0.014
L1	0.05REF		0.002REF	
h	0.07	0.17	0.003	0.007





















## RECOMMENDED PAD LAYOUT DIMENSIONS



Ref.	Millimeters	Inches
A	1.20	0.047
B	0.47	0.019
C	0.60	0.024

Part Number	Schematic Symbol	Polar	Device Marking Code	Reverse Stand-off Voltage	Reverse Leakage Current	Clamping Voltage (Tp=8/20us)	Peak Pulse Current (Tp=8/20us)	Off State Junction Capacitance
			$V_{RWM}(V)$	$V_{BR}(V)$	$I_R(\mu A)$	$V_C(V)$	$I_{PP}(A)$	$C_J(pF)$
SE5D50B5.0A		Bi	5	5.6	0.5	15	35	140
SE10F03B5.0LA		Bi	5	5.6	1	14	2	3.5
SE10F05B5.0LA		Bi	5	5.6	1	14	2	3.5
SE10F07B15MA		Bi	15	16	1	35	2	0.25
SE10F08B15A		Bi	15	18.5	0.1	23	3	10

Part Number	Schematic Symbol	Polar	Device Marking Code	Reverse Stand-off Voltage	Reverse Leakage Current	Clamping Voltage (Tp=8/20us)	Peak Pulse Current (Tp=8/20us)	Off State Junction Capacitance
			$V_{RWM}$ (V)	$V_{BR}$ (V)	$I_R$ (uA)	$V_C$ (V)	$I_{pp}$ (A)	$C_j$ (pF)
SE10F09B5.0A		Bi	5	8	0.1	11	8	15
SE10F10B3.3A		Bi	3.3	3.5	0.5	10	8	12
SE10F10B3.3MA		Bi	3.3	4	1	21	4	0.35
SE10F10B5.0A		Bi	5	8.4	0.1	10	8	18
SE10F10B5.0MA-SP		Bi	5	7	0.5	8	9	0.4
SE10F10B5.0LA		Bi	5	6	1	11	6	8
SE10F10B5.0MA		Bi	5	6	1	25	4	1
SE10F10B5.0UA		Bi	5	6	1	22	4	0.4
SE10F10B7.0A		Bi	7	7.5	1	19	8	25
SE10F10B12A		Bi	12	13.3	1	26	4	45
SE10F10B12LA		Bi	12	13.3/16	1	24	4	10
SE10F10B36MA		Bi	36	40	1	12	7	0.4
SE10F10U3.3MA		Uni	3.3	5	0.5	15	5	0.8
SE10F10U5.0A		Uni	5	6.2	1	12.3	8.7	65
SE10F10U5.0MA		Uni	5	6	1	15	4	0.4
SE10F10U7.0A		Uni	7	8.5	1	18	6	65
SE10F12B5.0UA		Bi	5	6	0.5	20	3	0.25
SE10F15B5.0A		Bi	5	5.6	0.5	18.6	8	15
SE10F15B24A		Bi	24	26.7	0.1	52	3.5	11
SE10F20B3.3A		Bi	3.3	3.5	1	12	15	50
SE10F20B5.0A		Bi	5	6	1	18	14	60

Part Number	Schematic Symbol	Polar	Device Marking Code	Reverse Stand-off Voltage	Reverse Leakage Current	Clamping Voltage (Tp=8/20us)	Peak Pulse Current (Tp=8/20us)	Off State Junction Capacitance
			$V_{RWM}$ (V)	$V_{BR}$ (V)	$I_R$ (uA)	$V_C$ (V)	$I_{pp}$ (A)	$C_j$ (pF)
SE10F20B8.0A		Bi	8	8.5	1	22	10	45
SE10F20B12A		Bi	12	14/14.5/15	0.1	19	8	8.5
SE10F20B15A		Bi	15	16.7	1	37	6	25
SE10F20B15LA		Bi	15	16.2	0.1	25	100	8.0
SE10F20B18A		Bi	18	19.5	1	47	4	45
SE10F20B24A		Bi	24	26.7	1	55	3	24
SE10F20B36A		Bi	36	40	1	73	2.2	12
SE10F20U12A		Uni	12	13.3	1	28	7	54
SE10F20U24A		Uni	24	26.7	0.5	40	8	35
SE10F20U70A		Uni	70	75	0.1	7	30	2
SE10F30B2.8A		Bi	2.8	4.2	0.5	14	22	60
SE10F30B3.3A		Bi	3.3	3.4	0.5	12	25	50
SE10F30B5.0A		Bi	5	9	1	20	20	40
SE10F30U30A		Uni	30	32	0.1	52	6.5	40
SE10F35B60A		Bi	60	65	1	100	3.5	10
SE10F35U5.0A		Uni	5	6	1	15	25	163
SE10F40B5.0A		Bi	5	5.8	1	20	20	33
SE10F45B4.5A		Bi	4.5	4.8	0.1	12	40	100
SE10F45B4.5A		Bi	4.5	4.8	0.1	12	40	100
SE10F06B8.5MA		Bi	8.5	8.7	0.2	16	3.8	1
SE10F10B3.3A		Bi	3.3	3.5	0.5	10	8	12





## DFN1006P3 PACKAGE INFORMATION

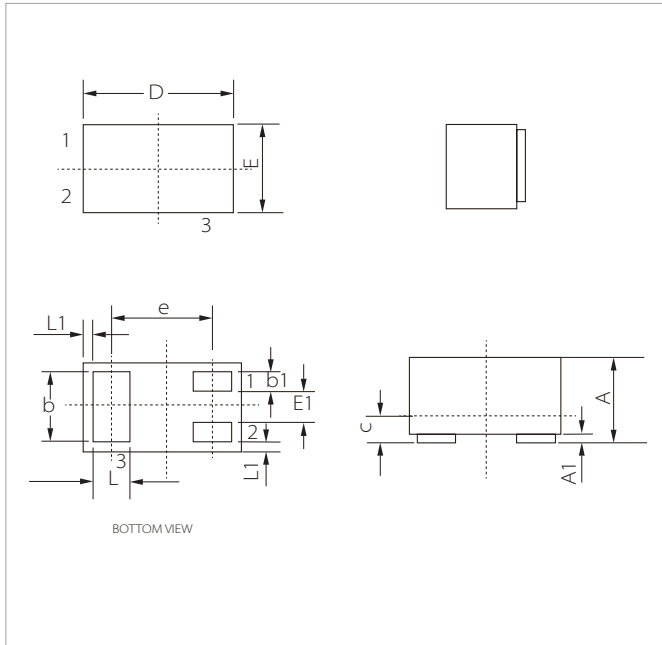

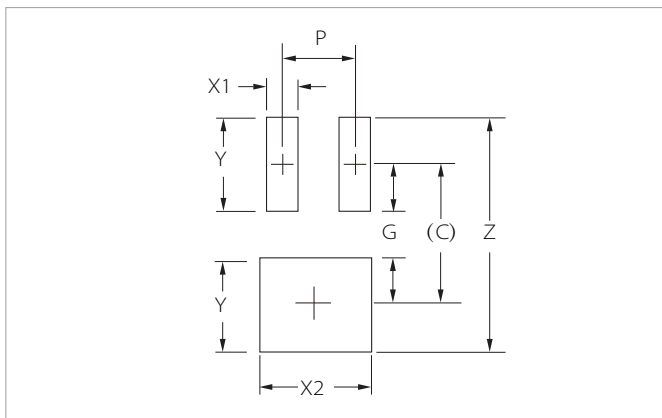

Ref.	Millimeters		Inches	
	Min.	Max.	Min.	Max.
A	0.35	0.50	0.014	0.020
A1	0	0.05	0	0.002
b	0.45	0.55	0.018	0.022
b1	0.10	0.20	0.004	0.008
c	0.12	0.18	0.005	0.007
D	0.95	1.05	0.037	0.041
e	0.65BSC		0.026BSC	
E	0.55	0.70	0.022	0.027
E1	0.20	0.30	0.008	0.014
L	0.20	0.30	0.008	0.012
L1	0.05REF		0.002REF	

## RECOMMENDED PAD LAYOUT DIMENSIONS



Ref.	Millimeters	Inches
C	(0.85)	(0.033)
P	0.40	0.016
G	0.30	0.012
X1	0.20	0.008
X2	0.60	0.024
Y	0.55	0.022
Z	1.40	0.055

Part Number	Schematic Symbol	Polar	Device Marking Code	Reverse Stand-off Voltage	Reverse Leakage Current	Clamping Voltage (Tp=8/20us)	Peak Pulse Current (Tp=8/20us)	Off State Junction Capacitance
			$V_{RWM}$ (V)	$V_{BR}$ (V)	$I_R$ (uA)	$V_C$ (V)	$I_{PP}$ (A)	$C_J$ (pF)
SE10P3F10B5.0B		Bi	5	6	1	30	3	10
SE10P3F10U5.0MB		Uni	5	6	1	19	4	0.6

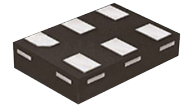

## DFN1109MP6 PACKAGE INFORMATION

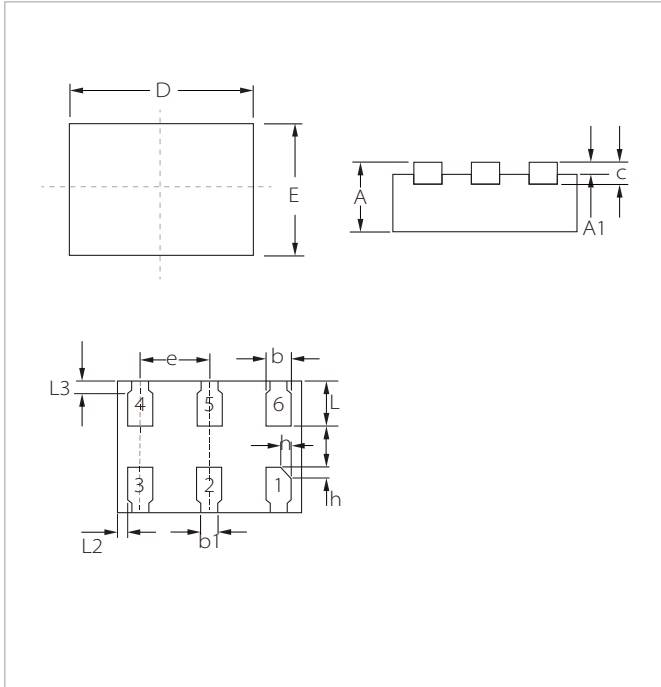

Ref.	Millimeters		Inches	
	Min.	Max.	Min.	Max.
A	0.45	0.55	0.018	0.022
A1	0	0.05	0	0.002
b	0.15	0.25	0.006	0.010
b1	0.14REF		0.005REF	
c	0.10	0.20	0.004	0.008
D	1.05	1.15	0.041	0.045
e	0.40BSC		0.016BSC	
E	0.85	0.95	0.033	0.037
L	0.30	0.40	0.012	0.016
L2	0.05REF		0.002REF	
L3	0.10REF		0.004REF	
h	0.05	0.15	0.008	0.012

## RECOMMENDED PAD LAYOUT DIMENSIONS

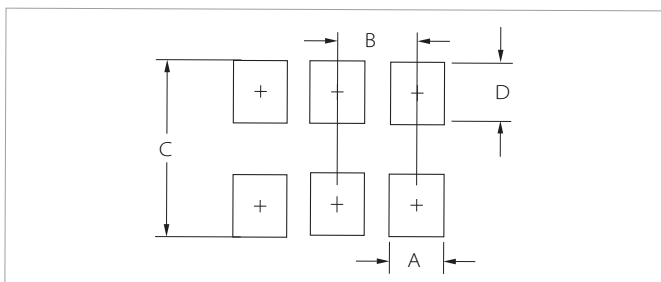

Ref.	Millimeters	Inches
	Nominal	Nominal
A	0.25	0.010
B	0.40	0.016
C	1.10	0.043
D	0.45	0.018

Part Number	Schematic Symbol	Polar	Device Marking Code	Reverse Stand-off Voltage	Reverse Leakage Current	Clamping Voltage (Tp=8/20us)	Peak Pulse Current (Tp=8/20us)	Off State Junction Capacitance
			$V_{RWM}$ (V)	$V_{BR}$ (V)	$I_R$ (uA)	$V_C$ (V)	$I_{pp}$ (A)	$C_j$ (pF)
SE11F09B5.0UD		Bi	5	6	0.1	30	3	0.25

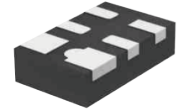

## DFN1610P6 PACKAGE INFORMATION

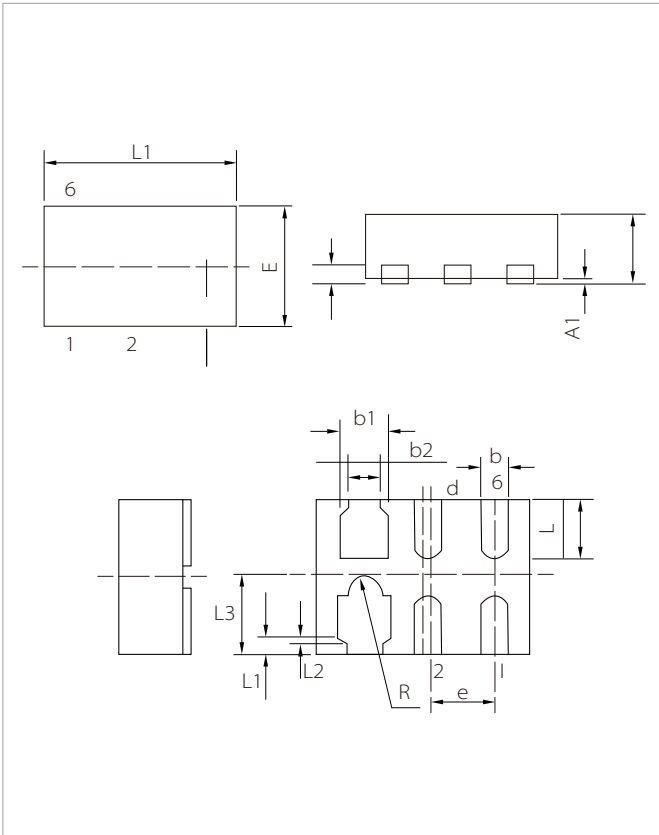

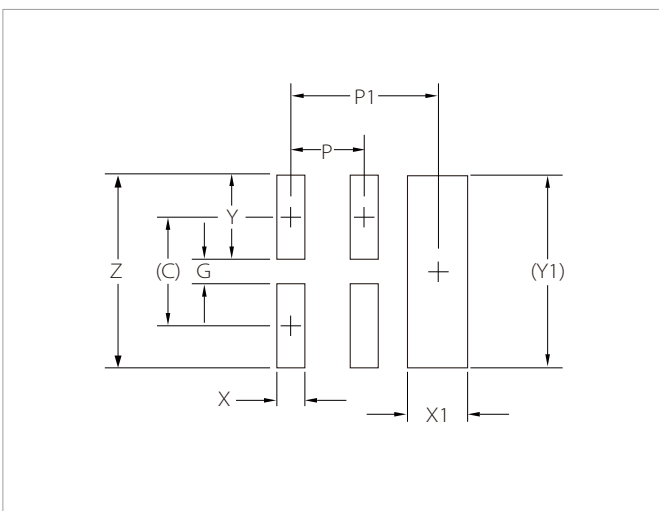

Ref.	Millimeters		Inches	
	Min.	Max.	Min.	Max.
A	0.45	0.55	0.018	0.022
A1	0	0.05	0	0.002
b	0.15	0.25	0.006	0.010
b1	0.35	0.45	0.014	0.018
b2	0.20	0.30	0.008	0.012
c	0.10	0.20	0.004	0.008
d	0.05TYP		0.002	
D	1.55	1.65	0.061	0.065
e	0.50BSC		0.020BSC	
E	0.95	1.05	0.037	0.041
L	0.30	0.45	0.012	0.018
L1	0.10REF		0.004REF	
L2	0.05REF		0.002REF	
L3	0.49REF		0.019REF	
R	0.08	0.18	0.003	0.007

## RECOMMENDED PAD LAYOUT DIMENSIONS



Ref.	Millimeters	Inches
C	0.875	0.034
G	0.20	0.008
P	0.50	0.020
P1	1.00	0.039
X	0.20	0.008
X1	0.40	0.016
Y	0.675	0.027
Y1	1.55	0.061
Z	1.55	0.061

Part Number	Schematic Symbol	Polar	Device Marking Code	Reverse Stand-off Voltage	Reverse Leakage Current	Clamping Voltage (Tp=8/20us)	Peak Pulse Current (Tp=8/20us)	Off State Junction Capacitance
			$V_{RWM}$ (V)	$V_{BR}$ (V)	$I_R$ (uA)	$V_C$ (V)	$I_{pp}$ (A)	$C_j$ (pF)
SE16P6F10B3.3MA		Bi	3.3	6.2	1	14	4	0.4
SE16P6F10B5.0MA		Bi	5	6	0.1	5	4	0.3



## SOD-523 PACKAGE INFORMATION

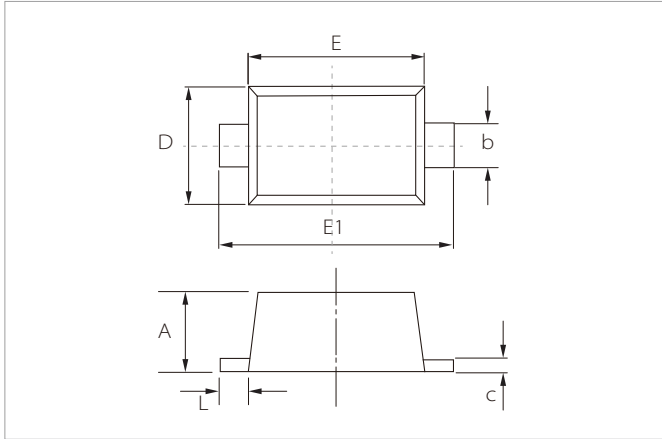





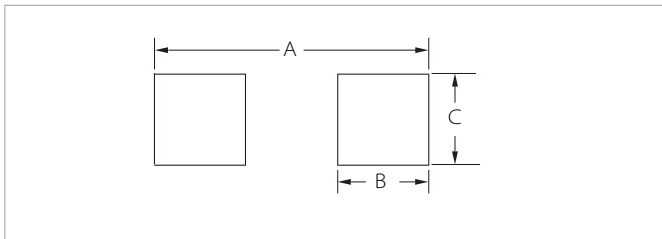







Ref.	Millimeters		Inches	
	Min.	Max.	Min.	Max.
A	0.50	0.80	0.020	0.031
b	0.25	0.35	0.010	0.014
c	0.07	0.20	0.003	0.008
D	0.70	0.90	0.028	0.035
E	1.10	1.30	0.043	0.051
E1	1.50	1.70	0.059	0.067
L	0.15	0.25	0.006	0.010

## RECOMMENDED PAD LAYOUT DIMENSIONS



Ref.	Millimeters		Inches	
	Min.	Max.	Min.	Max.
A	2.00		0.0787	
B	0.60		0.0236	
C	0.70		0.0276	

Part Number	Schematic Symbol	Polar	Device Marking Code	Reverse Stand-off Voltage	Reverse Leakage Current	Clamping Voltage (Tp=8/20us)	Peak Pulse Current (Tp=8/20us)	Off State Junction Capacitance
			$V_{RWM}(V)$	$V_{BR}(V)$	$I_R(\mu A)$	$V_C(V)$	$I_{PP}(A)$	$C_j(pF)$
SE5D10B3.3A		Bi	3.3	3.6	1	12	5	16.5
SE5D10B5.0A		Bi	5	6	1	25	5	15
SE5D10B5.0A		Bi	5	6	1	25	5	15
SE5D10B5.0AH		Bi	5	6	1	15	10	25
SE5D10B5.0LA		Bi	5	5.6	2	14	2	3
SE5D10B5.0MA		Bi	5	6/7.5/9	0.5	20	2	1.1
SE5D15B3.3A		Bi	3.3	5.5	1	15	8	10

Part Number	Schematic Symbol	Polar	Device Marking Code	Reverse Stand-off Voltage	Reverse Leakage Current	Clamping Voltage (Tp=8/20us)	Peak Pulse Current (Tp=8/20us)	Off State Junction Capacitance
			$V_{RWM}$ (V)	$V_{BR}$ (V)	$I_R$ (uA)	$V_C$ (V)	$I_{pp}$ (A)	$C_j$ (pF)
SE5D40B5.0A		Bi	5	5.8/7.8	1	20	20	40
SE5D10B12A		Bi	12	13.5	0.1	24	3.5	8
SE5D15U24A		Uni	24	26	0.2	46	3	16
SE5D20U5.0A		Uni	5	6	1	18.6	10	53.5
SE5D20U7.0A		Uni	7	7.5	0.2	22	8	47

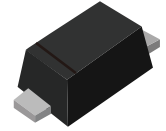

## SOD-523 PACKAGE INFORMATION

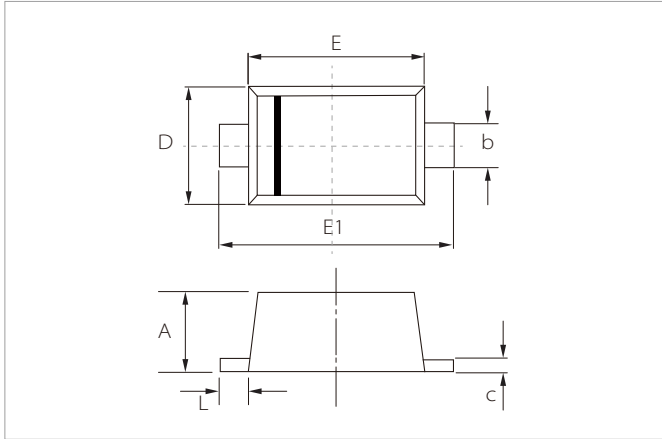





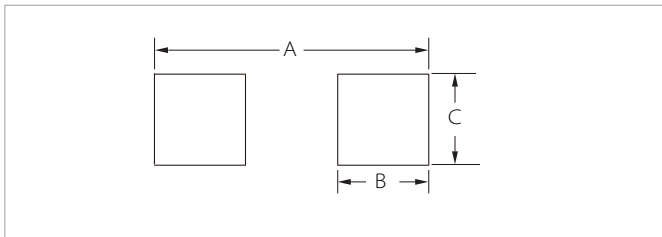



Ref.	Millimeters		Inches	
	Min.	Max.	Min.	Max.
A	0.50	0.80	0.020	0.031
b	0.25	0.35	0.010	0.014
c	0.07	0.20	0.003	0.008
D	0.70	0.90	0.028	0.035
E	1.10	1.30	0.043	0.051
E1	1.50	1.70	0.059	0.067
L	0.15	0.25	0.006	0.010

## RECOMMENDED PAD LAYOUT DIMENSIONS



Ref.	Millimeters		Inches	
	Min.	Min.	Min.	Min.
A	2.00		0.0787	
B	0.60		0.0236	
C	0.70		0.0276	

Part Number	Schematic Symbol	Polar	Device Marking Code	Reverse Stand-off Voltage	Reverse Leakage Current	Clamping Voltage (Tp=8/20us)	Peak Pulse Current (Tp=8/20us)	Off State Junction Capacitance
			$V_{RWM}$ (V)	$V_{BR}$ (V)	$I_R$ (uA)	$V_C$ (V)	$I_{PP}$ (A)	$C_j$ (pF)
SE5D10U5.0MA		Uni	5	6	1	15	4	0.4
SE5D10B5.0LA		Bi	5	5.6	2	14	2	3
SE5D15U3.3A		Uni	3.3	5	1	14.1	11.2	105
SE5D15U24A		Uni	24	26	0.2	46	3	16
SE5D20U5.0A		Uni	5	6	1	18.6	10	53.5
SE5D20U12A		Uni	12	14.1	1	26	4	45
SE5D35U24A		Uni	24	26.7	1	52	7	80

Part Number	Schematic Symbol	Polar	Device Marking Code	Reverse Stand-off Voltage	Reverse Leakage Current	Clamping Voltage (Tp=8/20us)	Peak Pulse Current (Tp=8/20us)	Off State Junction Capacitance
			$V_{RWM}$ (V)	$V_{BR}$ (V)	$I_R$ (uA)	$V_C$ (V)	$I_{pp}$ (A)	$C_j$ (pF)
SE5D15U12A		Bi	12	13.3	1	28	6	60



## DFN1610 PACKAGE INFORMATION

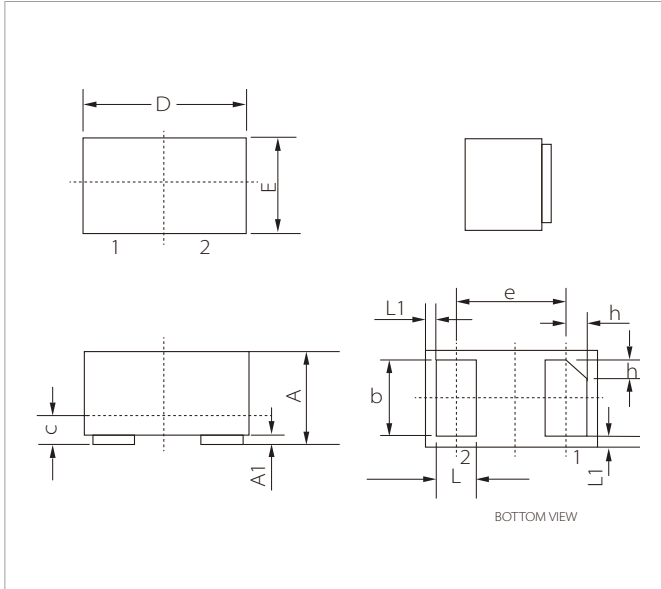



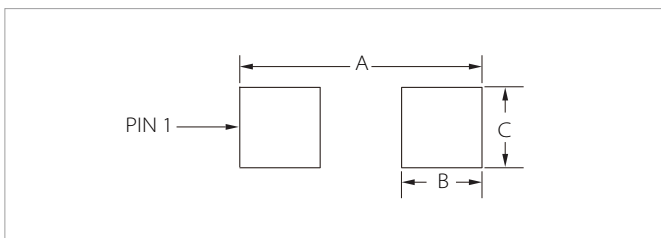

Ref.	Millimeters		Inches	
	Min.	Max.	Min.	Max.
A	0.45	0.55	0.018	0.022
A1	0	0.05	0	0.002
b	0.75	0.85	0.030	0.033
c	0.10	0.20	0.004	0.008
D	1.55	1.65	0.061	0.065
e	1.10TYP		0.043TYP	
E	0.95	1.05	0.037	0.041
L	0.35	0.45	0.014	0.018
L1	0.05REF		0.002REF	
h	0.15	0.25	0.006	0.010

## RECOMMENDED PAD LAYOUT DIMENSIONS



Ref.	Millimeters	Inches
A	1.85	0.073
B	0.625	0.025
C	1.00	0.039

Part Number	Schematic Symbol	Polar	Device Marking Code	Reverse Stand-off Voltage	Reverse Leakage Current	Clamping Voltage (Tp=8/20us)	Peak Pulse Current (Tp=8/20us)	Off State Junction Capacitance
			$V_{RWM}(V)$	$V_{BR}(V)$	$I_R(\mu A)$	$V_C(V)$	$I_{PP}(A)$	$C_j(pF)$
SE16F15B5.0MA		Bi	5	6	0.1	20	11	0.6
SE16F32B18A		Bi	18	19	1	40	8	90
SE16F110U6.5A		Uni	6.5	6.8	1	12.5	87	550
SE16F160U10A		Uni	10	10.5/12.5	0.1	22	72	600
SE16F160U18A		Uni	18	20	1	40	40	270

Part Number	Schematic Symbol	Polar	Device Marking Code	Reverse Stand-off Voltage	Reverse Leakage Current	Clamping Voltage (Tp=8/20us)	Peak Pulse Current (Tp=8/20us)	Off State Junction Capacitance
			$V_{RWM}$ (V)	$V_{BR}$ (V)	$I_R$ (uA)	$V_C$ (V)	$I_{pp}$ (A)	$C_j$ (pF)
SE16F180B4.5A		Bi	4.5	4.6	0.5	13	135	1500
SE16F200U7.0A		Uni	7	7.6/8.4/9	0.5	20	100	800
SE16F200U12A		Uni	12	17	1	28	70	500
SE16F180U5.0A		Uni	4.8	7.2	1	10.5	150	1200

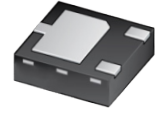



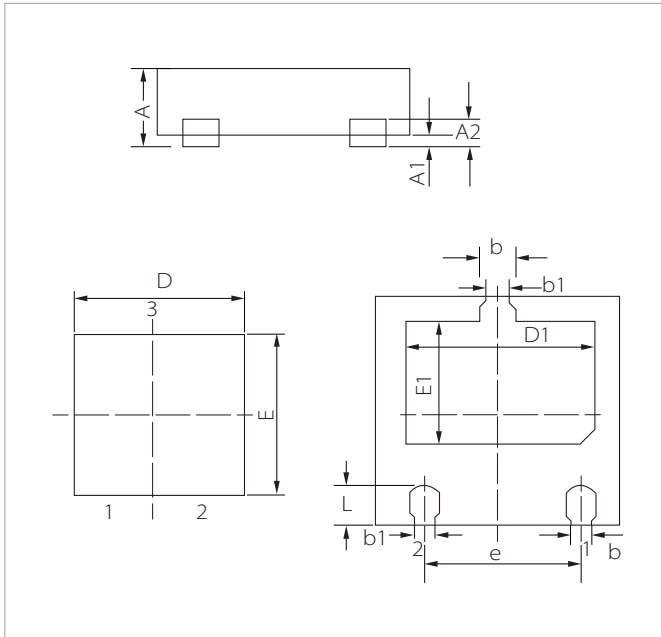

## DFN2020-3L PACKAGE INFORMATION



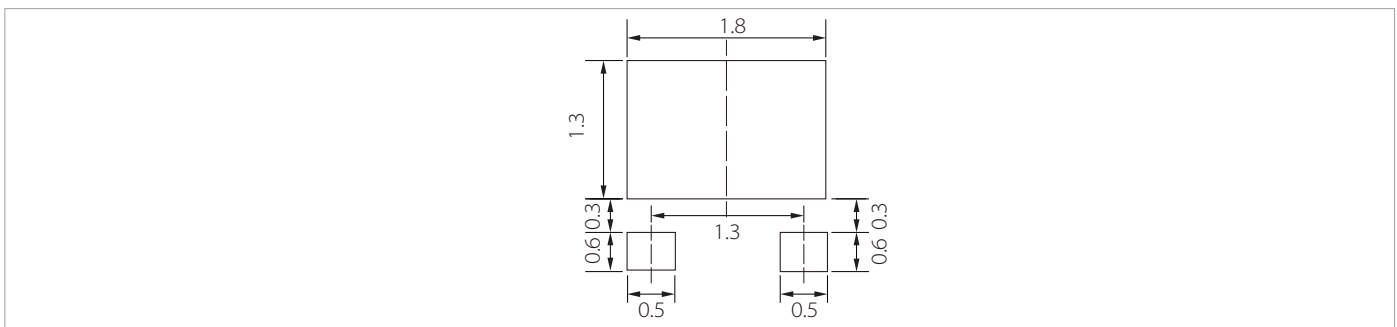

Ref.	Millimeters		
	Min.	Typ.	Max.
A	0.45	0.55	0.65
A1	-	0.00	0.05
A2	0.152BSC		
D	1.80	2.00	2.20
E	1.80	2.00	2.20
b	0.15	0.20	0.25
b1	0.25	0.30	0.35
D1	1.45	1.50	1.55
E1	1.00	1.05	1.10
e	1.30BSC		
L	0.35	0.40	0.45

## RECOMMENDED PAD LAYOUT DIMENSIONS



Part Number	Schematic Symbol	Polar	Device Marking Code	Reverse Stand-off Voltage	Reverse Leakage Current	Clamping Voltage (Tp=8/20us)	Peak Pulse Current (Tp=8/20us)	Off State Junction Capacitance
			V <sub>RWM</sub> (V)	V <sub>BR</sub> (V)	I <sub>r</sub> (uA)	V <sub>c</sub> (V)	I <sub>pp</sub> (A)	C <sub>j</sub> (pF)
SE22F3P600U15B		Uni	15	19	0.1	45	150	1200
SE22F400U10A		Uni	10	16	1	32	18	1400
SE22F500B4.5A		Bi	4.5	6.1	1	20	240	600

Part Number	Schematic Symbol	Polar	Device Marking Code	Reverse Stand-off Voltage	Reverse Leakage Current	Clamping Voltage (Tp=8/20us)	Peak Pulse Current (Tp=8/20us)	Off State Junction Capacitance
			$V_{RWM}$ (V)	$V_{BR}$ (V)	$I_R$ (uA)	$V_C$ (V)	$I_{pp}$ (A)	$C_j$ (pF)
SE22F500U24A		Uni	24	26.5	1	45	110	750
SE22F600U10A		Uni	10	11.8	1	26	22	1500
SE22F800U24A		Uni	24	26.5	1	45	180	700

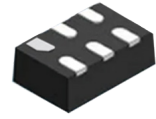

## DFN1510TP6 PACKAGE INFORMATION

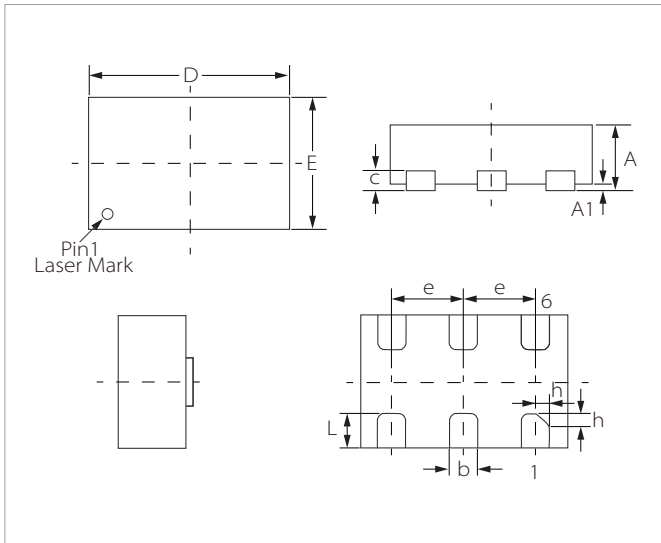

Ref.	Millimeters		
	Min.	Nom.	Max.
A	0.45	0.55	0.65
A1	-	0.02	0.05
b	0.15	0.20	0.25
c	0.15		
D	1.40	1.50	1.60
E	0.90	1.00	1.10
e	0.50BSC		
L	0.25	0.30	0.35
h	0.08	0.10	0.12

Part Number	Schematic Symbol	Polar	Device Marking Code	Reverse Stand-off Voltage	Reverse Leakage Current	Clamping Voltage (Tp=8/20us)	Peak Pulse Current (Tp=8/20us)	Off State Junction Capacitance
			$V_{RWM}$ (V)	$V_{BR}$ (V)	$I_R$ (uA)	$V_C$ (V)	$I_{pp}$ (A)	$C_j$ (pF)
SELC0522P		Uni	5	6	0.1	30	2.5	0.25

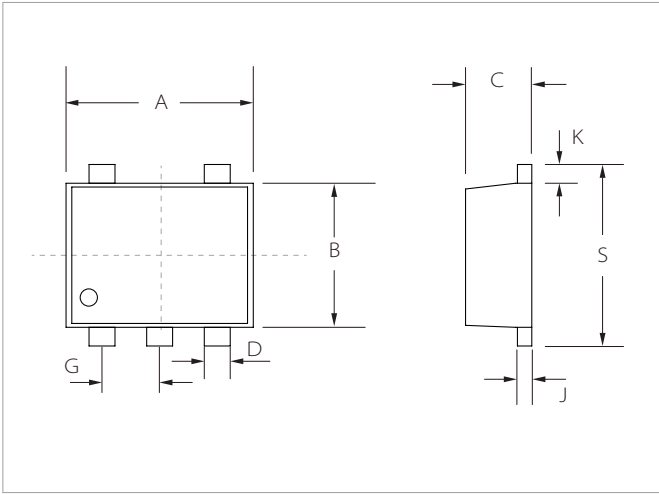

## SOT-553 PACKAGE INFORMATION

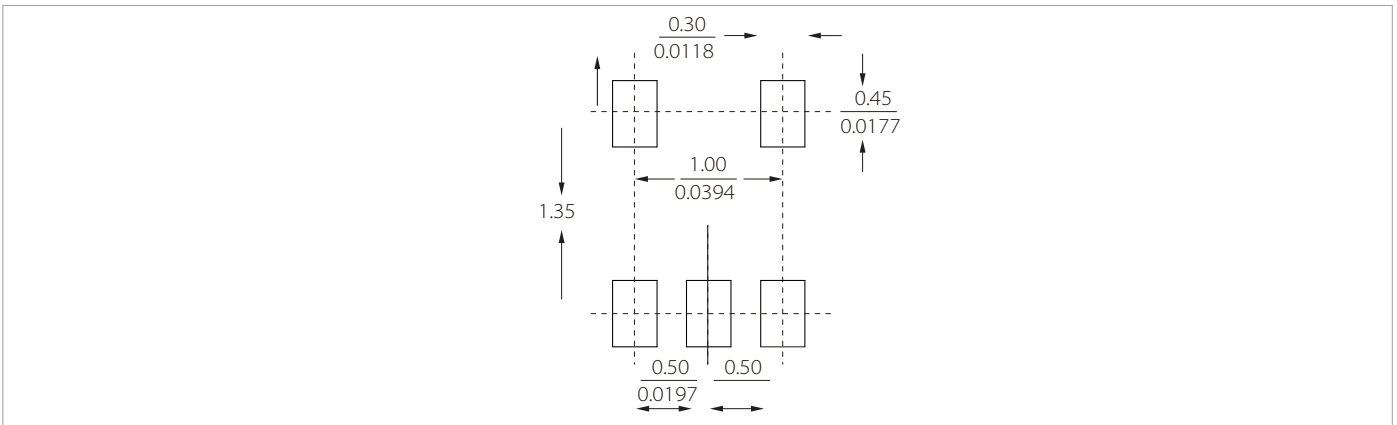

Ref.	Millimeters		Inches	
	Min.	Max.	Min.	Max.
A	1.50	1.70	0.059	0.067
B	1.10	1.30	0.043	0.051
C	0.50	0.60	0.020	0.024
D	0.17	0.27	0.007	0.011
G	0.50BSC		0.020BSC	
J	0.08	0.18	0.003	0.007
K	0.10	0.30	0.004	0.012
S	1.50	1.70	0.059	0.067

## RECOMMENDED PAD LAYOUT DIMENSIONS



Part Number	Schematic Symbol	Polar	Device Marking Code	Reverse Stand-off Voltage	Reverse Leakage Current	Clamping Voltage (Tp=8/20us)	Peak Pulse Current (Tp=8/20us)	Off State Junction Capacitance
			$V_{RWM}$ (V)	$V_{BR}$ (V)	$I_R$ (uA)	$V_C$ (V)	$I_{pp}$ (A)	$C_j$ (pF)
SE55T10U5.0D		Uni	5	6	1	17	3.1	6.7
SE55T10U5.0MC		Uni	5	6	1	16	3.5	0.9

## SOT-523 PACKAGE INFORMATION

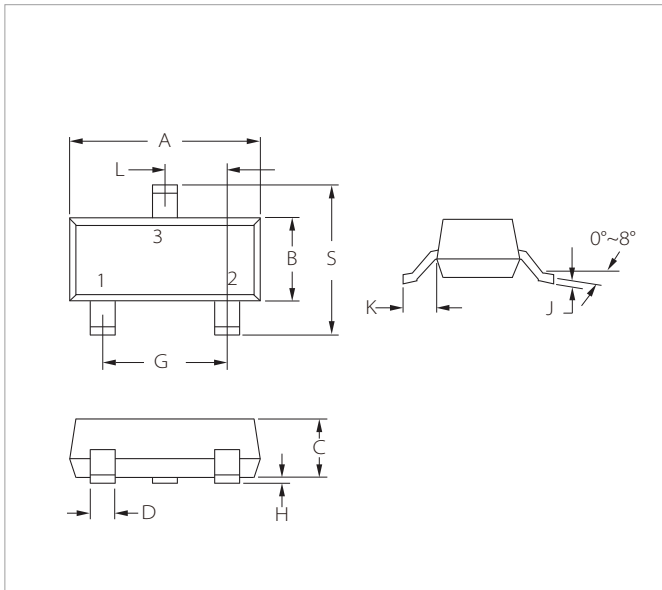

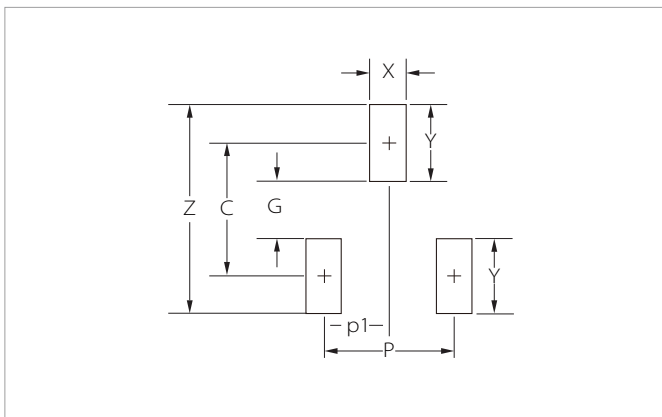

Ref.	Millimeters		Inches	
	Min.	Max.	Min.	Max.
A	1.50	1.70	0.059	0.067
B	0.75	0.85	0.029	0.033
C	0.60	0.80	0.023	0.031
D	0.15	0.30	0.005	0.012
G	1.00BSC		0.039BSC	
H	0.00	0.10	0.000	0.004
J	0.10	0.20	0.004	0.008
K	(0.22)		(0.009)	
L	0.50BSC		0.020BSC	
S	1.45	1.75	0.057	0.069

## RECOMMENDED PAD LAYOUT DIMENSIONS



Ref.	Millimeters	Inches
C	(1.40)	(0.055)
P	1.00	0.039
p1	0.50	0.020
G	0.60	0.024
X	0.40	0.016
Y	0.80	0.031
Z	2.20	0.087

Part Number	Schematic Symbol	Polar	Device Marking Code	Reverse Stand-off Voltage	Reverse Leakage Current	Clamping Voltage (Tp=8/20us)	Peak Pulse Current (Tp=8/20us)	Off State Junction Capacitance
			$V_{RWM}$ (V)	$V_{BR}$ (V)	$I_R$ (uA)	$V_C$ (V)	$I_{pp}$ (A)	$C_j$ (pF)
SE35T10B5.0B		Bi	5	6	1	10	10	15
SE35T12U5.0MB		Uni	5	6	1	25	4	1



## DFN2010P5 PACKAGE INFORMATION

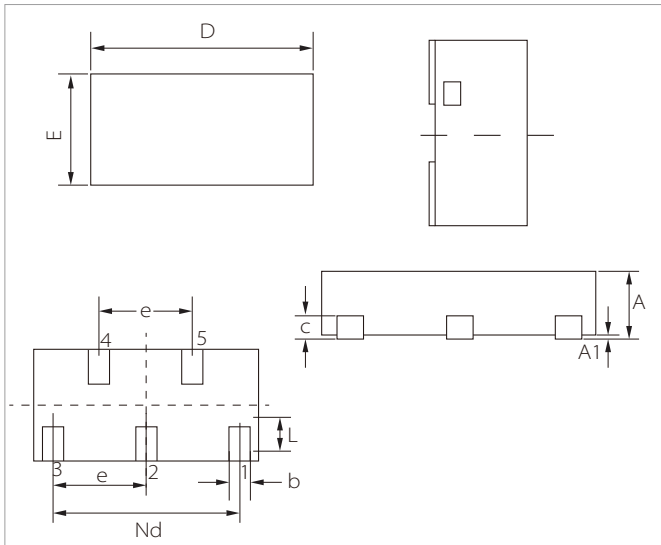

Ref.	Millimeters		Inches	
	Min.	Max.	Min.	Max.
A	0.45	0.55	0.018	0.022
A1	0.00	0.05	0.000	0.002
b	0.15	0.25	0.006	0.010
c	0.152REF		0.006REF	
D	1.95	2.05	0.077	0.081
Nd	1.60BSC		0.063BSC	
e	0.80BSC		0.031BSC	
E	0.95	1.05	0.037	0.041
L	0.30	0.40	0.012	0.016

## RECOMMENDED PAD LAYOUT DIMENSIONS

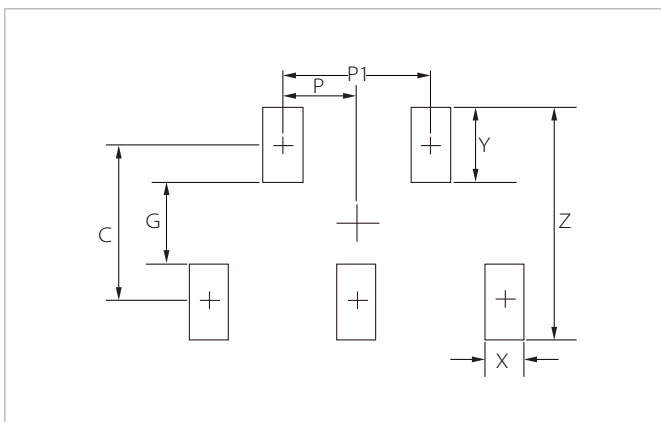

Ref.	Millimeters	Inches
C	0.85	0.033
G	0.25	0.010
P	0.40	0.016
P1	0.80	0.031
X	0.20	0.008
Y	0.60	0.024
Z	1.45	0.057

Part Number	Schematic Symbol	Polar	Device Marking Code	Reverse Stand-off Voltage	Reverse Leakage Current	Clamping Voltage (Tp=8/20us)	Peak Pulse Current (Tp=8/20us)	Off State Junction Capacitance
			$V_{RWM}(V)$	$V_{BR}(V)$	$I_R(\mu A)$	$V_C(V)$	$I_{pp}(A)$	$C_j(pF)$
SEULC7534P5		Uni	5	6	0.1	25	4.5	0.5



## SOT-323 PACKAGE INFORMATION

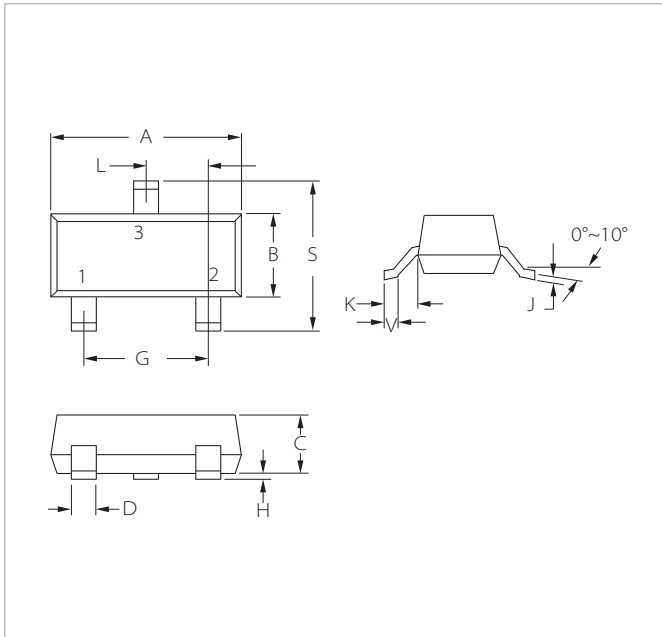

Ref.	Millimeters		Inches	
	Min.	Max.	Min.	Max.
A	2.00	2.20	0.079	0.087
B	1.15	1.35	0.045	0.053
C	0.90	1.00	0.035	0.039
D	0.20	0.40	0.008	0.016
G	1.20	1.40	0.047	0.055
H	0.00	0.10	0.000	0.004
J	0.08	0.15	0.003	0.006
K	0.525REF		0.021REF	
L	0.650TYP		0.026TYP	
S	2.15	2.45	0.085	0.096
V	0.26	0.46	0.010	0.018

## RECOMMENDED PAD LAYOUT DIMENSIONS

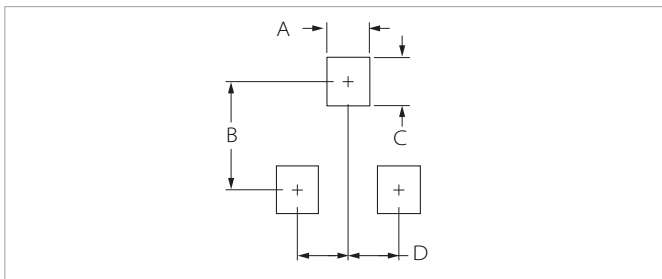

Ref.	Millimeters	Inches
	NOR	NOR
A	0.50	0.020
B	2.20	0.087
C	0.80	0.031
D	1.30	0.051

Part Number	Schematic Symbol	Polar	Device Marking Code	Reverse Stand-off Voltage	Reverse Leakage Current	Clamping Voltage (Tp=8/20us)	Peak Pulse Current (Tp=8/20us)	Off State Junction Capacitance
			$V_{RWM}$ (V)	$V_{BR}$ (V)	$I_R$ (uA)	$V_C$ (V)	$I_{pp}$ (A)	$C_j$ (pF)
SE33T25B24B		Bi	24	26.7	0.5	44	6	14

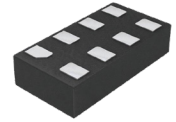

## DFN2010P8 PACKAGE INFORMATION

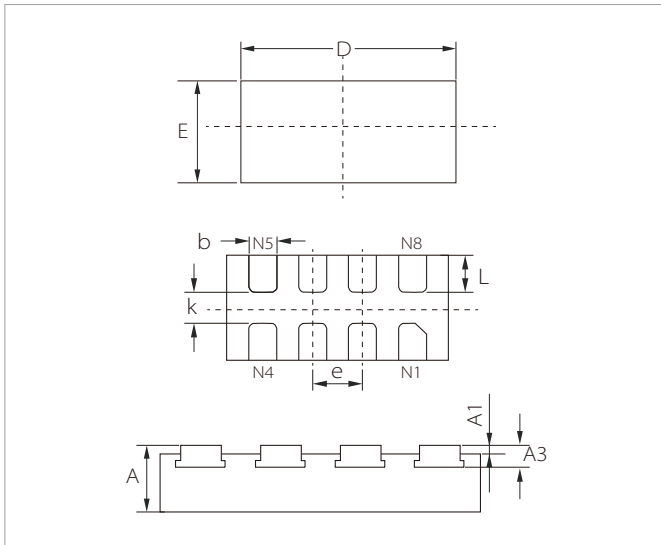

Ref.	Millimeters		Inches	
	Min.	Max.	Min.	Max.
A	0.320	0.400	0.013	0.016
A1	0.000	0.046	0.000	0.002
A3	0.110REF		0.004REF	
D	1.900	2.100	0.075	0.083
E	0.900	1.100	0.035	0.043
k	0.300REF		0.012REF	
b	0.200	0.300	0.008	0.012
e	0.500TYP		0.020TYP	
L	0.274	0.426	0.011	0.017

## RECOMMENDED PAD LAYOUT DIMENSIONS

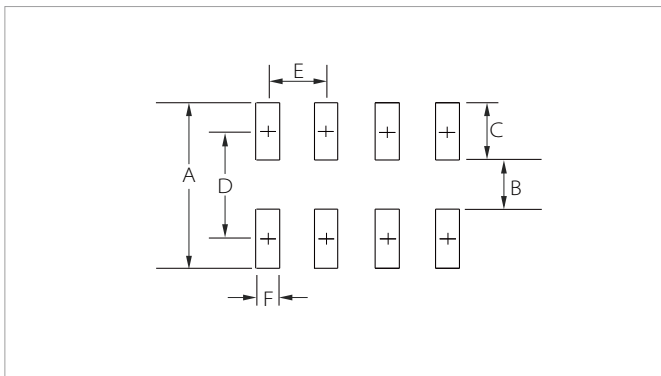

Ref.	Millimeters	Inches
A	1.55	0.061
B	0.25	0.010
C	0.65	0.026
D	0.90	0.035
E	0.50	0.020
F	0.30	0.012

Part Number	Schematic Symbol	Polar	Device Marking Code	Reverse Stand-off Voltage	Reverse Leakage Current	Clamping Voltage (Tp=8/20us)	Peak Pulse Current (Tp=8/20us)	Off State Junction Capacitance
			$V_{RWM}$ (V)	$V_{BR}$ (V)	$I_R$ (uA)	$V_C$ (V)	$I_{pp}$ (A)	$C_j$ (pF)
SE20F20B3.0MA		Bi	3	3.5	0.1	17	13	0.6

## SOT-363 PACKAGE INFORMATION

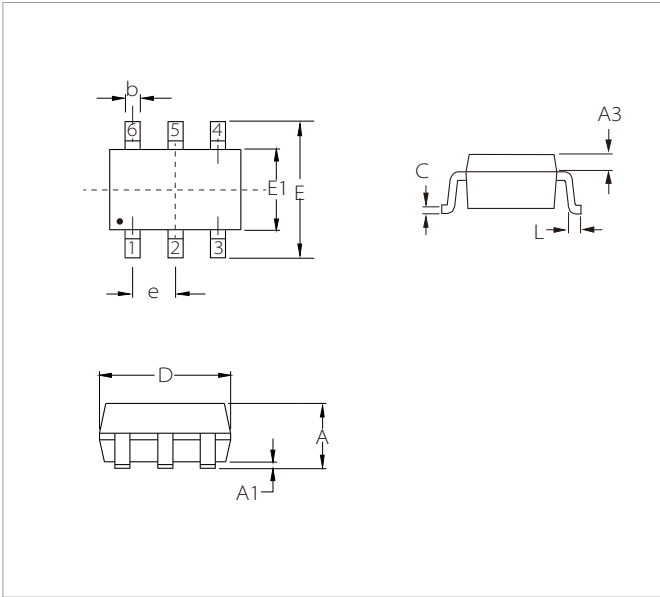

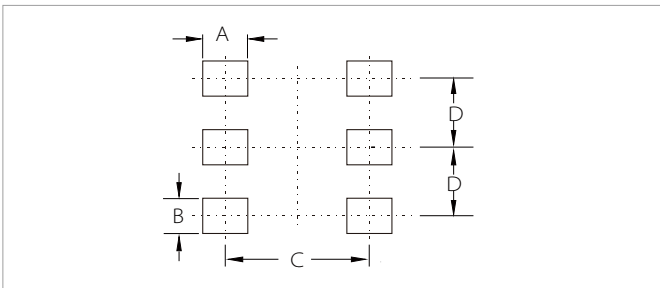

Ref.	Millimeters		Inches	
	Min.	Max.	Min.	Max.
A	0.800	1.100	0.031	0.043
A1	0.000	0.100	0.000	0.004
A3	0.20REF		0.008REF	
D	1.800	2.200	0.070	0.086
E1	1.150	1.350	0.045	0.053
E	2.000	2.200	0.078	0.086
e	0.65BSC		0.026BSC	
b	0.100	0.300	0.004	0.012
L	0.100	0.300	0.004	0.012
C	0.100	0.250	0.004	0.010

## RECOMMENDED PAD LAYOUT DIMENSIONS



Ref.	Millimeters	Inches
A	0.50	0.0197
B	0.40	0.0157
C	1.90	0.0748
D	0.65	0.0250

Part Number	Schematic Symbol	Polar	Device Marking Code	Reverse Stand-off Voltage	Reverse Leakage Current	Clamping Voltage (Tp=8/20us)	Peak Pulse Current (Tp=8/20us)	Off State Junction Capacitance
			$V_{RWM}(V)$	$V_{BR}(V)$	$I_R(\mu A)$	$V_C(V)$	$I_{PP}(A)$	$C_j(pF)$
SE63T10U5.0E		Uni	5	6	1	15	8	60
SE63T10U5.0LD1		Uni	5	6	1	25	4	0.5

## SOT-353 PACKAGE INFORMATION

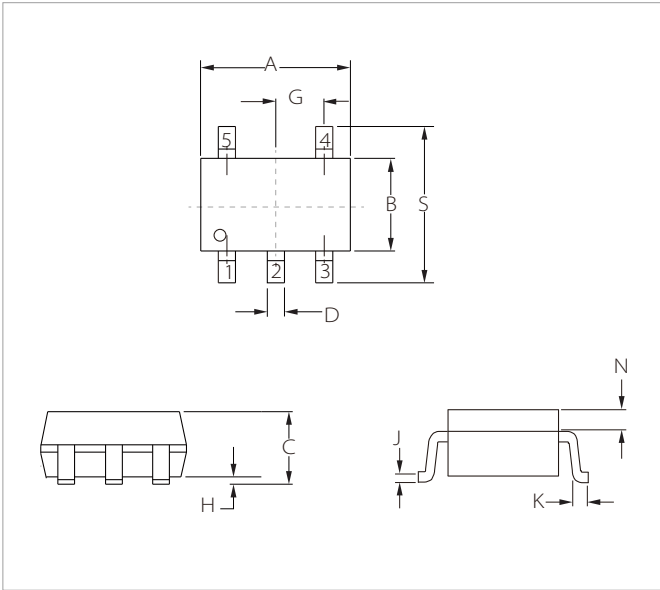

Ref.	Millimeters		Inches	
	Min.	Max.	Min.	Max.
A	1.80	2.20	0.071	0.087
B	1.15	1.35	0.045	0.053
C	0.80	1.10	0.031	0.043
D	0.10	0.30	0.004	0.012
G	0.65BSC		0.26BSC	
H	--	0.10	--	0.004
J	0.10	0.25	0.004	0.010
K	0.10	0.30	0.004	0.012
N	0.20REF		0.008REF	
S	2.0	2.2	0.079	0.087

## RECOMMENDED PAD LAYOUT DIMENSIONS

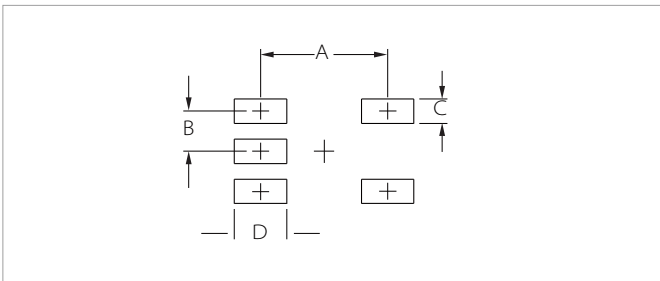

Ref.	Millimeters	Inches
	NOR	NOR
A	1.90	0.0748
B	0.65	0.025
C	0.40	0.0157
D	0.50	0.0197

Part Number	Schematic Symbol	Polar	Device Marking Code	Reverse Stand-off Voltage	Reverse Leakage Current	Clamping Voltage (Tp=8/20us)	Peak Pulse Current (Tp=8/20us)	Off State Junction Capacitance
			$V_{RWM}$ (V)	$V_{BR}$ (V)	$I_R$ (uA)	$V_C$ (V)	$I_{pp}$ (A)	$C_j$ (pF)
SE53T10U5.0D		Uni	5	6	1	12	7.5	40
SE53T10U5.0MC		Uni	5	6	0.1	15	4	0.8
SE53T10U6.0MC		Uni	6	7	0.5	15	2	0.35

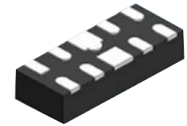

## DFN2510P10 PACKAGE INFORMATION

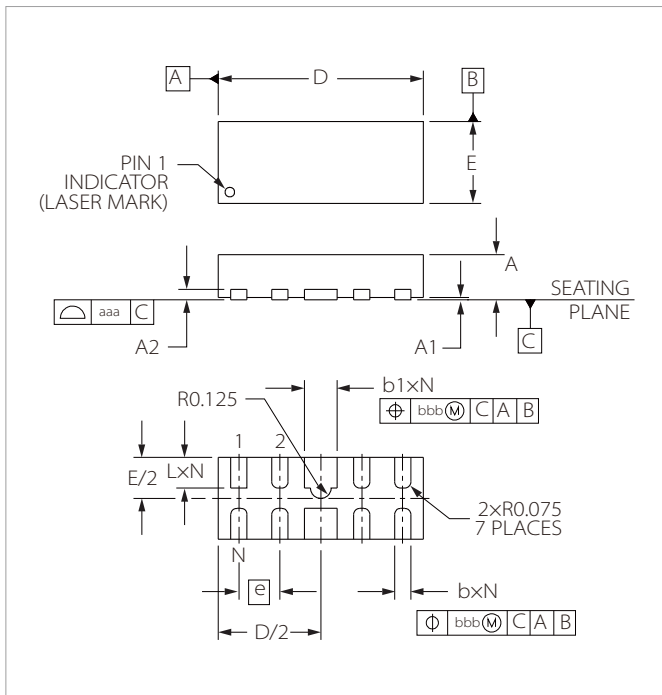



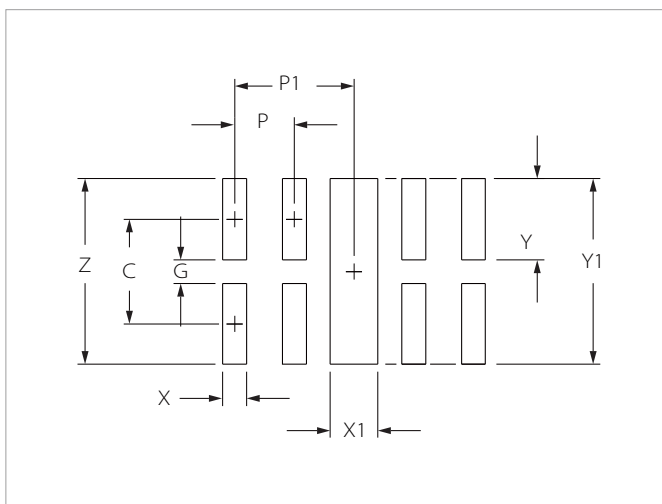

Ref.	Millimeters		Inches	
	Min	Max	Min	Max
A	0.40	0.65	0.016	0.026
A1	0	0.05	0	0.002
A2	(0.13)		(0.005)	
b	0.15	0.25	0.006	0.010
b1	0.35	0.45	0.014	0.018
D	2.40	2.60	0.094	0.102
E	0.90	1.10	0.035	0.043
e	0.50BSC		0.020BSC	
L	0.30	0.45	0.012	0.018
N	8		8	
aaa	0.08		0.003	
bbb	0.10		0.004	

## RECOMMENDED PAD LAYOUT DIMENSIONS



Ref.	Millimeters	Inches
C	0.87	0.034
G	0.20	0.008
P	0.50	0.020
P1	1.00	0.039
X	0.20	0.008
X1	0.40	0.016
Y	0.68	0.027
Y1	1.55	0.061
Z	1.55	0.061

Part Number	Schematic Symbol	Polar	Device Marking Code	Reverse Stand-off Voltage	Reverse Leakage Current	Clamping Voltage (Tp=8/20us)	Peak Pulse Current (Tp=8/20us)	Off State Junction Capacitance
			V <sub>RWM</sub> (V)	V <sub>BR</sub> (V)	I <sub>R</sub> (uA)	V <sub>C</sub> (V)	I <sub>pp</sub> (A)	C <sub>j</sub> (pF)
SE21T10U5.0MD		Uni	5	6	1	16	5	0.6

Part Number	Schematic Symbol	Polar	Device Marking Code	Reverse Stand-off Voltage	Reverse Leakage Current	Clamping Voltage (Tp=8/20us)	Peak Pulse Current (Tp=8/20us)	Off State Junction Capacitance
			$V_{RWM}$ (V)	$V_{BR}$ (V)	$I_R$ (uA)	$V_C$ (V)	$I_{pp}$ (A)	$C_j$ (pF)
SEULC0524PA		Uni	5	6	0.5	11	3	0.6
SEULC0524PW		Bi	5	6	1	15	5	0.65
SEULC3304P		Uni	3.3	4	1	25	10	0.4
SEULC3324P10		Uni	3.3	4.2	1	14	4	0.4
SEULC3324P-SP		Uni	3.3	6.3	0.5	5	5	0.55

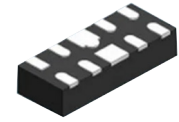

## DFN2510P10 PACKAGE INFORMATION

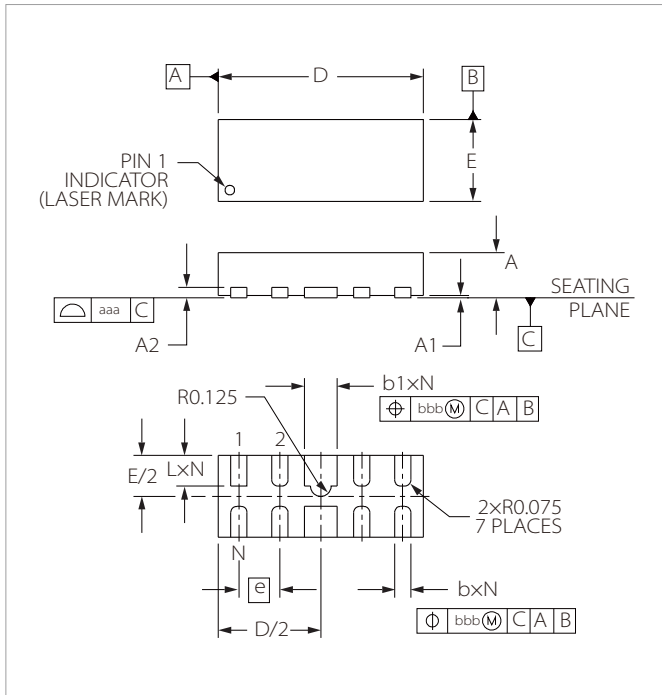

Ref.	Millimeters		Inches	
	Min.	Max.	Min.	Max.
A	0.40	0.65	0.016	0.026
A1	0	0.05	0	0.002
A2	(0.13)		(0.005)	
b	0.15	0.25	0.006	0.010
b1	0.35	0.45	0.014	0.018
D	2.40	2.60	0.094	0.102
E	0.90	1.10	0.035	0.043
e	0.50BSC		0.020BSC	
L	0.30	0.45	0.012	0.018
N	8		8	
aaa	0.08		0.003	
bbb	0.10		0.004	

## RECOMMENDED PAD LAYOUT DIMENSIONS

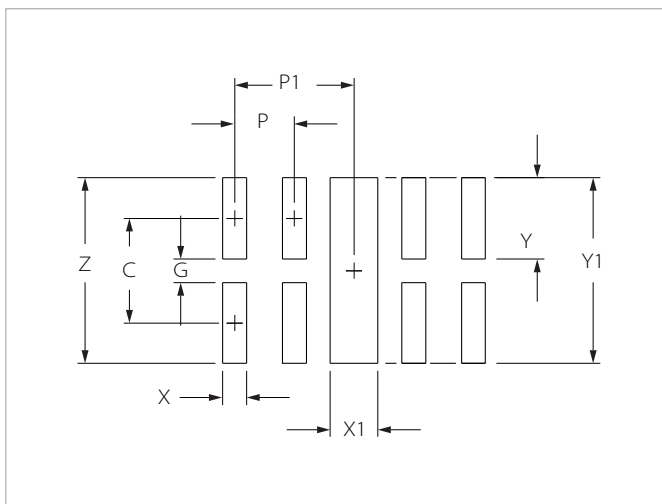

Ref.	Millimeters	Inches
C	0.87	0.034
G	0.20	0.008
P	0.50	0.020
P1	1.00	0.039
X	0.20	0.008
X1	0.40	0.016
Y	0.68	0.027
Y1	1.55	0.061
Z	1.55	0.061

Part Number	Schematic Symbol	Polar	Device Marking Code	Reverse Stand-off Voltage	Reverse Leakage Current	Clamping Voltage (Tp=8/20us)	Peak Pulse Current (Tp=8/20us)	Off State Junction Capacitance
			V <sub>RWM</sub> (V)	V <sub>BR</sub> (V)	I <sub>R</sub> (uA)	V <sub>C</sub> (V)	I <sub>pp</sub> (A)	C <sub>j</sub> (pF)
SEULC0524P		Uni	5	6	1	16	5	0.6



## SOD-323 PACKAGE INFORMATION

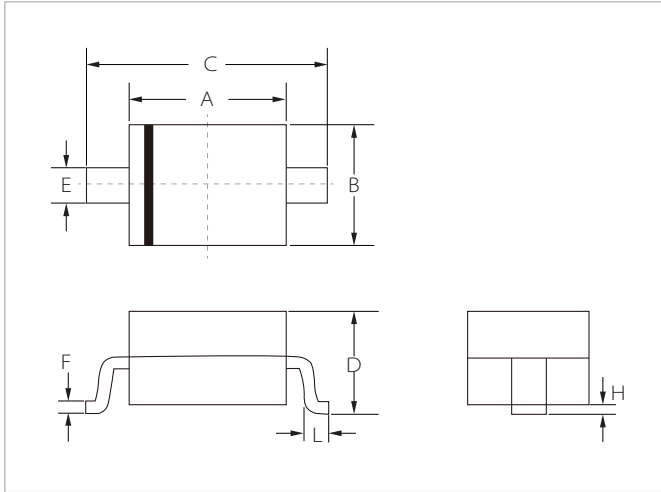

Ref.	Millimeters		Inches	
	Min.	Max.	Min.	Max.
A	1.60	1.90	0.063	0.075
B	1.15	1.45	0.045	0.057
C	2.39	2.75	0.094	0.108
D	0.80	1.10	0.031	0.043
E	0.25	0.40	0.010	0.016
F	0.10	0.20	0.004	0.008
H	-	0.10	-	0.004
L	0.20	0.40	0.008	0.016



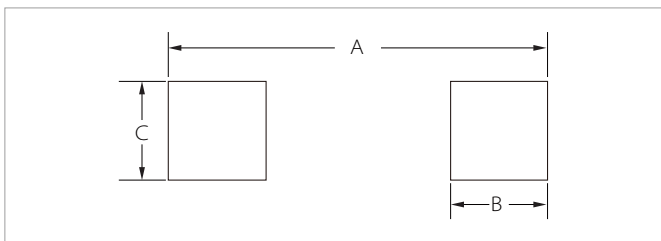

















## RECOMMENDED PAD LAYOUT DIMENSIONS































Ref.	Millimeters		Inches	
	Min.	Max.	Min.	Max.
A	2.87	3.12	0.113	0.123
B	0.66	0.91	0.026	0.036
C	0.66	0.91	0.026	0.036

Part Number	Schematic Symbol	Polar	Device Marking Code	Reverse Stand-off Voltage	Reverse Leakage Current	Clamping Voltage (Tp=8/20us)	Peak Pulse Current (Tp=8/20us)	Off State Junction Capacitance
			$V_{RWM}$ (V)	$V_{BR}$ (V)	$I_R$ (uA)	$V_C$ (V)	$I_{pp}$ (A)	$C_j$ (pF)
SE3D35U12A		Uni	2.5	3.3	1	10	40	85
SE3D35U15A		Uni	15	16.7	1	30	12	120
SE3D35U24A		Uni	24	26.7	1	52	7	80
SE3D35U36A		Uni	36	40	1	75	5	60
SE3D35U5.0A		Uni	5	6	0.2	14.5	24	200
SE3D35U5.0MA		Uni	12	13.5	0.5	32	11	130



Part Number	Schematic Symbol	Polar	Device Marking Code	Reverse Stand-off Voltage	Reverse Leakage Current	Clamping Voltage (Tp=8/20us)	Peak Pulse Current (Tp=8/20us)	Off State Junction Capacitance
			$V_{RWM}$ (V)	$V_{BR}$ (V)	$I_R$ (uA)	$V_C$ (V)	$I_{pp}$ (A)	$C_j$ (pF)
SE3D10B5.0A		Bi	5	6	0.5	12	8	18
SE3D15B3.3MA		Bi	3.3	4.6	0.1	16	20	1
SE3D15B8.0MA		Bi	8	8.5	1	26	10	1
SE3D15B36MA		Bi	36	40	1	75	2	1
SE3D20U30A		Uni	30	4	40	16	20	450
SE3D35B3.3A		Bi	3.3	3.3	1	10	40	85
SE3D35B3.3MA		Bi	3.3	4.6	0.1	16	20	1
SE3D35B5.0A		Bi	5	5.5	0.2	25	20	39
SE3D35B5.0MA		Bi	5	6	0.2	25	14	1.5
SE3D35B8.0A		Bi	8	8.5	2	24	15	120
SE3D35B8.0MA		Bi	8	8.5	0.2	24	18	1
SE3D35B12A		Bi	12	13.3	1	29.8	12	45
SE3D35B12MA		Bi	12	13.3	0.2	28.6	12	1
SE3D35B15A		Bi	15	16.7	0.2	38	10	45
SE3D35B15MA		Bi	15	16.7	0.2	38	10	1
SE3D35B18A		Bi	24	26.7	0.2	52	7	24
SE3D35B24MA		Bi	24	26.7	0.2	56	6	1
SE3D35B36A		Bi	36	40	0.2	75	4.5	18
SE3D35U3.3MA		Bi	3.3	4	40	21	15	1
SE3D35U36A		Uni	36	40	1	75	5	60
SE3D140U5.0A		Uni	5	6	1	15.5	100	1000

Part Number	Schematic Symbol	Polar	Device Marking Code	Reverse Stand-off Voltage	Reverse Leakage Current	Clamping Voltage (Tp=8/20us)	Peak Pulse Current (Tp=8/20us)	Off State Junction Capacitance
			$V_{RWM}$ (V)	$V_{BR}$ (V)	$I_R$ (uA)	$V_C$ (V)	$I_{pp}$ (A)	$C_j$ (pF)
SE3D170U12A		Uni	12	13.5	1	28	60	350
SE3D200B5.0A		Bi	5	5.3	1	16	130	450
SE3D200U7.0A		Uni	7	7.5	1	25	100	800
SE3D250B4.5A		Bi	4.5	4.8	1	14.5	160	500
SE3D250U4.5A		Uni	4.5	4.8	1	18	140	1000
SE3D300B5.0A		Bi	5	5.3	1	16	130	450
SESD05		Uni	5	6	0.2	14.5	24	200
SESD12		Uni	12	13.3	0.5	32	11	130
SESD12C		Uni	12	13.3	1	29.8	12	45
SE3D15B5.0A		Bi	5	5.6	0.1	16	7	18
SE3D15B5.0MA		Bi	5	6	0.2	25	14	1.5
SE3D20B3.3MA		Bi	3.3	6	1	8	25	1.5
SE3D35B3.3MA		Bi	3.3	4.6	0.2	16	20	1
SE3D35B5.0A		Bi	5	5.5	0.2	25	20	39
SE3D35B8.0MA		Bi	8	8.5	0.2	24	18	1
SE3D35B12A		Bi	12	13.3	1	29.8	12	45
SE3D35B12MA		Bi	12	13.3	0.2	28.6	12	1
SE3D35B15A		Bi	15	16.7	0.2	38	10	45
SE3D35B15MA		Bi	15	16.7	0.2	38	10	1
SE3D35B18MA		Bi	18	20	0.2	45	8	1
SE3D35B24A		Bi	24	26.7	0.2	52	7	24

Part Number	Schematic Symbol	Polar	Device Marking Code	Reverse Stand-off Voltage	Reverse Leakage Current	Clamping Voltage (Tp=8/20us)	Peak Pulse Current (Tp=8/20us)	Off State Junction Capacitance
			$V_{RWM}$ (V)	$V_{BR}$ (V)	$I_R$ (uA)	$V_C$ (V)	$I_{pp}$ (A)	$C_j$ (pF)
SE3D35B24MA		Bi	24	26.7	0.2	56	6	1
SE3D35B36A		Bi	36	40	0.2	75	4.5	18
SE3D35U5.0A		Uni	5	6	0.2	14.5	24	200
SE3D35U12A		Uni	12	13.3	0.2	32	11	90
SE3D50B3.3A		Bi	3.3	4	0.5	13	40	90
SE3D50U12A		Uni	12	13.3	0.5	32	15	90
SE3D170U12A		Uni	12	13.5	1	28	60	350
SE3D170U12A		Uni	12	13.5	1	28	60	350

## SOT-143 PACKAGE INFORMATION

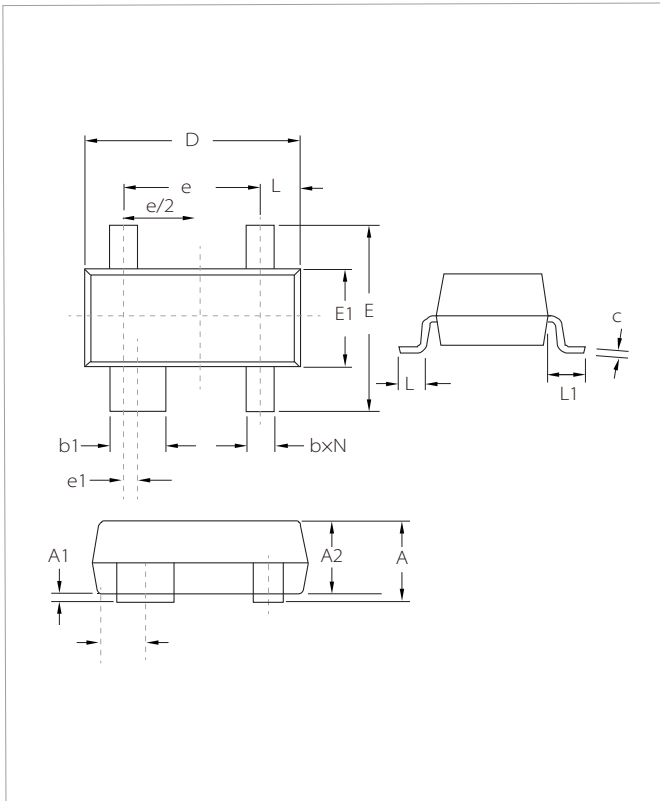



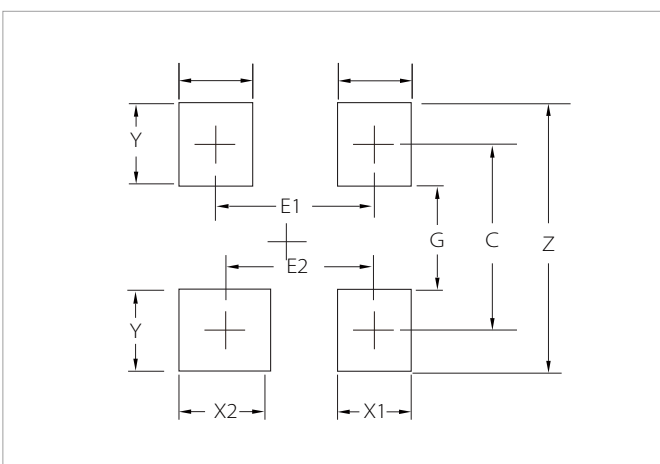

Ref.	Millimeters		Inches	
	Min.	Max.	Min.	Max.
A	0.80	1.22	0.031	0.048
A1	0.013	0.15	0.000	0.008
A2	0.75	1.07	0.029	0.042
b	0.30	0.51	0.011	0.020
b1	0.76	0.94	0.029	0.037
c	0.06	0.20	0.002	0.008
D	2.80	3.04	0.110	0.120
E	2.10	2.64	0.082	0.104
E1	1.20	1.40	0.047	0.055
e	1.92BSC		0.075	
e1	0.20BSC		0.008	
L	0.40	0.60	0.015	0.024
L1	(0.54)		(0.021)	
N	4		4	

## RECOMMENDED PAD LAYOUT DIMENSIONS



Ref.	Millimeters	Inches
C	(2.2)	(0.087)
E1	1.92	0.076
E2	1.72	0.068
G	0.80	0.031
X1	1.00	0.039
X2	1.20	0.047
Y	1.40	0.055
Z	3.60	0.141

Part Number	Schematic Symbol	Polar	Device Marking Code	Reverse Stand-off Voltage	Reverse Leakage Current	Clamping Voltage (Tp=8/20us)	Peak Pulse Current (Tp=8/20us)	Off State Junction Capacitance
			$V_{RWM}$ (V)	$V_{BR}$ (V)	$I_R$ (uA)	$V_C$ (V)	$I_{pp}$ (A)	$C_j$ (pF)
SE41T06U5.0LB		Uni	5	6	0.5	15	4	2
SE41T10U5.0LB1		Uni	5	6	1	25	5	2
SESR05		Uni	5	6	1	25	5	2
SESR70		Uni	70	85	0.5	16	21	1.5

## SOT-23 PACKAGE INFORMATION

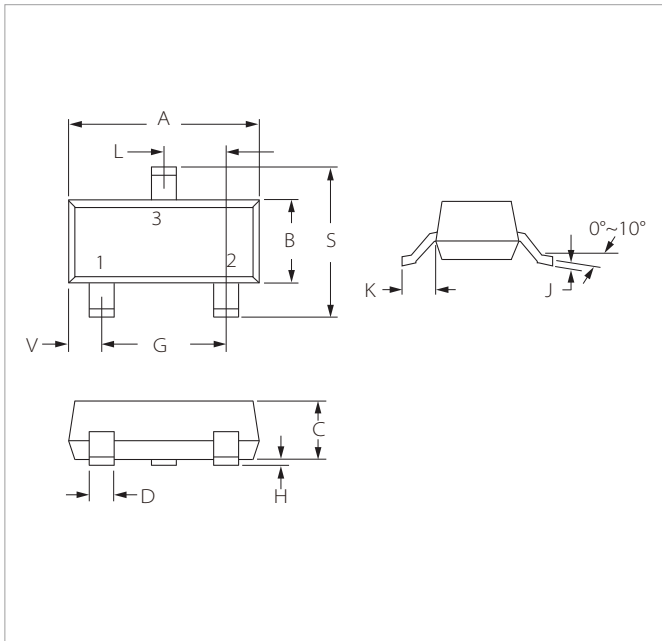

Ref.	Millimeters		Inches	
	Min.	Max.	Min.	Max.
A	2.80	3.04	0.110	0.120
B	1.20	1.40	0.047	0.055
C	0.89	1.11	0.035	0.044
D	0.37	0.50	0.015	0.020
G	1.78	2.04	0.070	0.081
H	0.01	0.100	0.001	0.004
J	0.085	0.180	0.003	0.007
K	0.35	0.69	0.014	0.029
L	0.89	1.02	0.035	0.040
S	2.10	2.64	0.083	0.104
V	0.45	0.60	0.018	0.024

## RECOMMENDED PAD LAYOUT DIMENSIONS

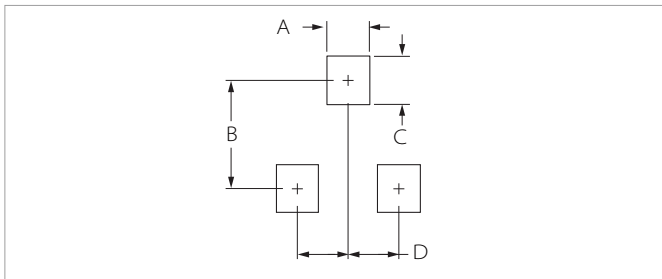

Ref.	Millimeters		Inches	
	Min.	Max.	Min.	Max.
A	0.71	0.97	0.028	0.038
B	1.88	2.13	0.074	0.084
C	0.71	0.97	0.028	0.038
D	0.81	1.07	0.032	0.042

Part Number	Schematic Symbol	Polar	Device Marking Code	Reverse Stand-off Voltage	Reverse Leakage Current	Clamping Voltage (Tp=8/20us)	Peak Pulse Current (Tp=8/20us)	Off State Junction Capacitance
			$V_{RWM}$ (V)	$V_{BR}$ (V)	$I_R$ (uA)	$V_C$ (V)	$I_{pp}$ (A)	$C_j$ (pF)
SE23T08B5.0B		Bi	5	6	0.5	10	8	20
SE23T10B5.0UB		Bi	5	8.5	0.1	25	4	0.6
SE23T10U5.0MA		Uni	5	6	1	25	4	0.4

Part Number	Schematic Symbol	Polar	Device Marking Code	Reverse Stand-off Voltage	Reverse Leakage Current	Clamping Voltage (Tp=8/20us)	Peak Pulse Current (Tp=8/20us)	Off State Junction Capacitance
			$V_{RWM}$ (V)	$V_{BR}$ (V)	$I_R$ (uA)	$V_C$ (V)	$I_{pp}$ (A)	$C_j$ (pF)
SE23T20B24LB		Bi	24	26	1	50	3	13
SE23T20B30C		Bi	30	33	0.1	55	3	20
SE23T35B3.0B		Bi	3.3	4	40	1	20	450
SE23T35B5.0B		Bi	5	6	10	18	17	200
SE23T35B12B		Bi	12	13.3	1	32	11	75
SE23T35B24B		Bi	24	26.7	1	52	7	5
SE23T35U5.0B		Uni	5	6	10	16	24	300
SE23T35U12B		Uni	12	13.3	10	24	13	150
SE23T35U24B		Uni	24	26.7	1	52	6	90
SE23T35U36B		Uni	36	40	10	75	5	60
SE23T40B712B		Bi	12	13.3	1	26	17	55
SE23T50B5.0B		Bi	5	5.6	1.0	22	23	65
SE23T50U12B		Uni	12	13	1	25	20	100
SESM712		Bi	12	13.3	1	26	17	55

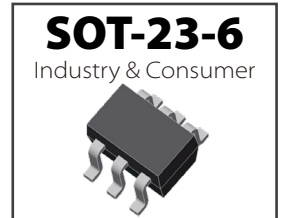

## SOT-23-6 PACKAGE INFORMATION

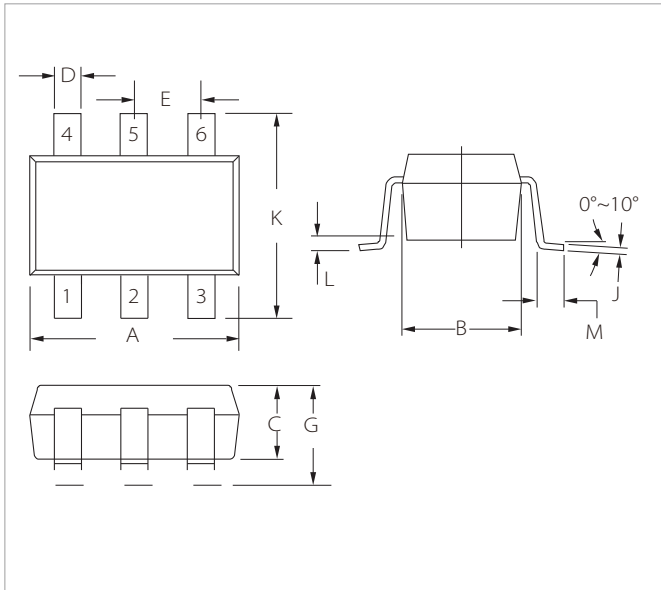



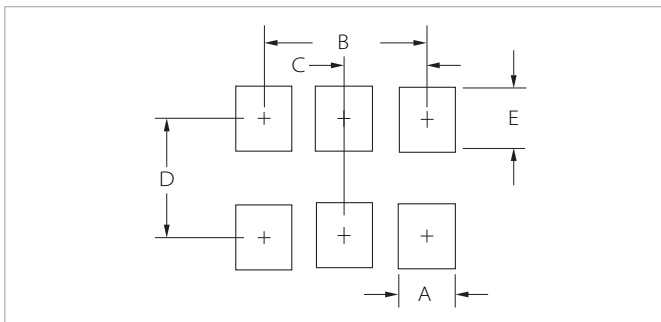

Ref.	Millimeters		Inches	
	Min.	Max.	Min.	Max.
A	2.80	3.05	0.110	0.120
B	1.50	1.75	0.059	0.070
C	0.90	1.30	0.036	0.051
D	0.25	0.50	0.010	0.020
E	0.85	1.05	0.033	0.040
G	0.90	1.45	0.036	0.057
J	0.09	0.20	0.003	0.008
K	2.60	3.00	0.102	0.118
L	0.0	0.15	0.0	0.006
M	0.30	0.60	0.012	0.024

## RECOMMENDED PAD LAYOUT DIMENSIONS



Ref.	Millimeters	Inches
	Nominal	Nominal
A	0.70	0.028
B	1.90	0.074
C	0.95	0.037
D	2.40	0.094
E	1.00	0.039

Part Number	Schematic Symbol	Polar	Device Marking Code	Reverse Stand-off Voltage	Reverse Leakage Current	Clamping Voltage (Tp=8/20us)	Peak Pulse Current (Tp=8/20us)	Off State Junction Capacitance
			$V_{RWM}(V)$	$V_{BR}(V)$	$I_R(\mu A)$	$V_C(V)$	$I_{PP}(A)$	$C_j(pF)$
SESRV05-4		Uni	5	6	1	17.5	5	0.3
SESRV05-4A		Uni	5	6	0.5	15	4	0.4
SESRV05-4H		Uni	5	6	1	25	12	1.5
SESRV05-4LV		Uni	5	6	0.1	9.3	5	4



## SOT-23-5 PACKAGE INFORMATION

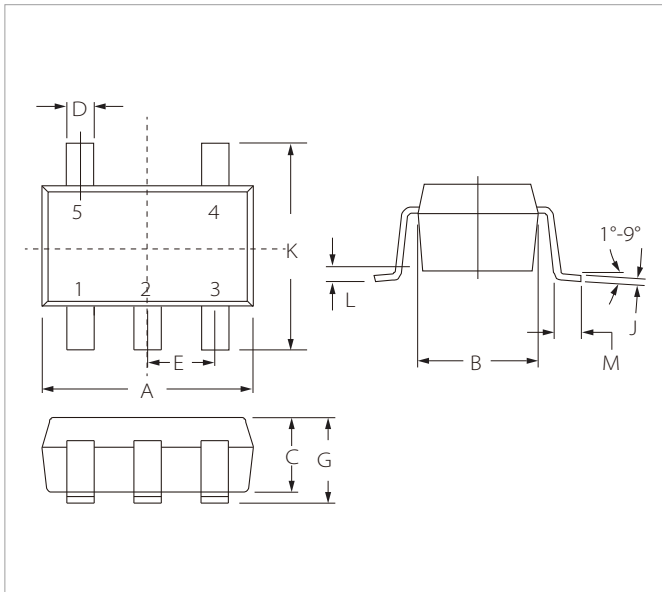





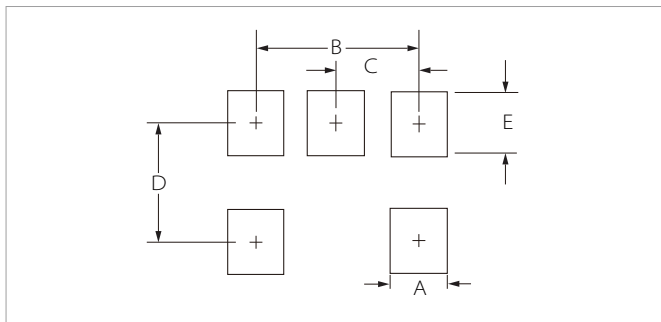





Ref.	Millimeters		Inches	
	Min.	Max.	Min.	Max.
A	2.80	3.10	0.110	0.122
B	1.50	1.80	0.059	0.071
C	0.90	1.30	0.036	0.051
D	0.25	0.50	0.010	0.020
E	0.95(Typ)		0.037(Typ)	
G	0.90	1.40	0.036	0.055
J	0.08	0.25	0.003	0.010
K	2.60	3.00	0.102	0.118
L	0.00	0.10	0.00	0.004
M	0.37	2.64	0.014	-

## RECOMMENDED PAD LAYOUT DIMENSIONS



Ref.	Millimeters	Inches
	Nominal	Nominal
A	0.70	0.028
B	1.90	0.074
C	0.95	0.037
D	2.40	0.094
E	1.00	0.039

Part Number	Schematic Symbol	Polar	Device Marking Code	Reverse Stand-off Voltage	Reverse Leakage Current	Clamping Voltage (Tp=8/20us)	Peak Pulse Current (Tp=8/20us)	Off State Junction Capacitance
			$V_{RWM}$ (V)	$V_{BR}$ (V)	$I_R$ (uA)	$V_C$ (V)	$I_{pp}$ (A)	$C_j$ (pF)
SE25T10B5.0D		Bi	5	6	1	25	4	20
SE25T10U3.3MA		Uni	3.6	4.2	0.5	8.7	5	0.55
SE26T10U5.0ME		Uni	5	6	1	17.5	5	0.3

Part Number	Schematic Symbol	Polar	Device Marking Code	Reverse Stand-off Voltage	Reverse Leakage Current	Clamping Voltage (Tp=8/20us)	Peak Pulse Current (Tp=8/20us)	Off State Junction Capacitance
			$V_{RWM}$ (V)	$V_{BR}$ (V)	$I_R$ (uA)	$V_C$ (V)	$I_{pp}$ (A)	$C_j$ (pF)
SE26T12B5.0LB1		Bi	5	6	1	20	6.2	1
SE26T15B3.3E		Bi	3.3	3.8	0.1	10.5	13	15
SE26T15U24A		Uni	24	29.4	0.1	45	3.4	2.3
SE26T30U3.3LD1		Uni	3.3	3.5	1	15	22	1.5
SE26T35U12D		Uni	12	13.3	1	36	14	130
SE26T50U5.0LA		Uni	5	6	1	25	20	2
SE26T50U12D		Uni	12	29.4	1	36	14	70

## SOD-123 PACKAGE INFORMATION

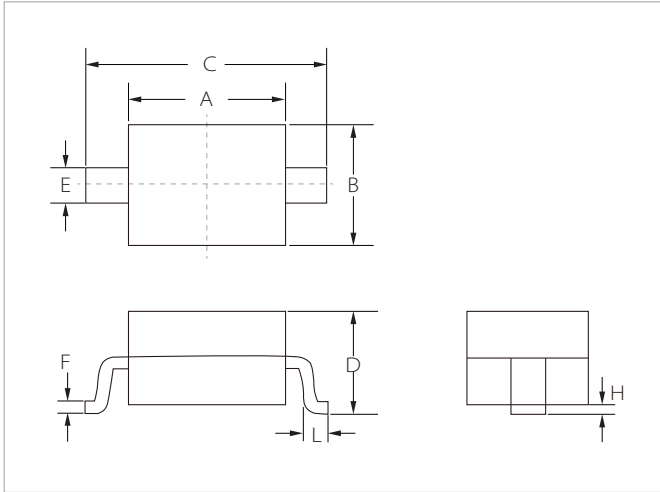

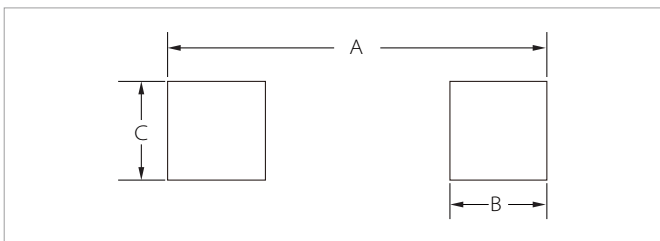

Ref.	Millimeters		Inches	
	Min.	Max.	Min.	Max.
A	2.60	2.80	0.102	0.110
B	1.50	1.70	0.059	0.067
C	3.55	3.85	0.140	0.152
D	1.05	1.25	0.041	0.049
E	0.45	0.65	0.018	0.026
F	0.08	0.15	0.003	0.006
H	0.00	0.10	0.000	0.004
L	0.25	0.45	0.010	0.018

## RECOMMENDED PAD LAYOUT DIMENSIONS



Ref.	Millimeters		Inches	
	Min.	Max.	Min.	Max.
A	4.00	4.30	0.157	0.169
B	0.75	0.85	0.030	0.033
C	0.95	1.05	0.037	0.041

Part Number	Schematic Symbol	Polar	Device Marking Code	Reverse Stand-off Voltage	Reverse Leakage Current	Clamping Voltage (Tp=8/20us)	Peak Pulse Current (Tp=8/20us)	Off State Junction Capacitance
			$V_{RWM}$ (V)	$V_{BR}$ (V)	$I_R$ (uA)	$V_C$ (V)	$I_{PP}$ (A)	$C_j$ (pF)
SE1D40B2.5A		Bi	2.5	3.3	1	10	40	85
SE1D40B712A		Bi	7/12	7.5/13.5	1	12/26	17	55



## SOP-8 PACKAGE INFORMATION

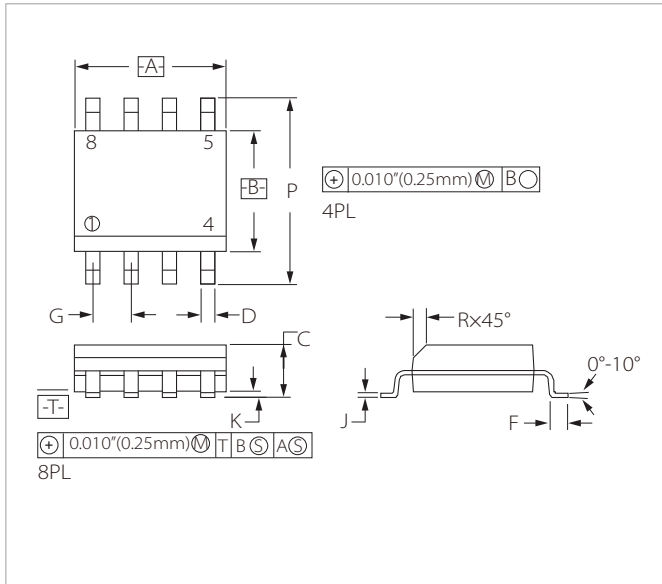

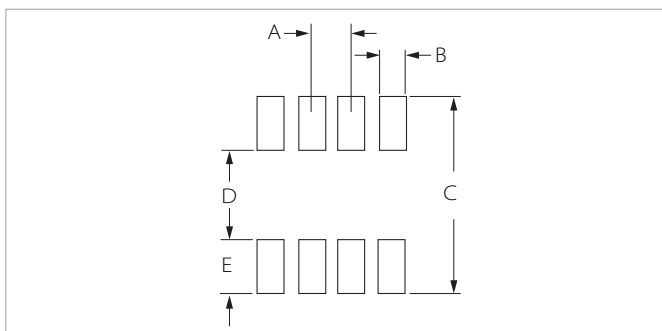

Ref.	Millimeters		Inches	
	Min.	Max.	Min.	Max.
A	4.80	5.00	0.189	0.196
B	3.80	4.00	0.150	0.157
C	1.35	1.75	0.054	0.068
D	0.35	0.49	0.014	0.019
F	0.40	1.25	0.016	0.049
G	1.27BSC		0.050BSC	
J	0.18	0.25	0.007	0.009
K	0.10	0.25	0.004	0.008
P	5.80	6.20	0.229	0.244
R	0.25	0.50	0.010	0.019

## RECOMMENDED PAD LAYOUT DIMENSIONS



Ref.	Millimeters		Inches	
	Min.	Max.	Min.	Max.
A	1.14	1.40	0.045	0.055
B	0.64	0.89	0.025	0.035
C	6.22	-	0.245	-
D	3.94	4.17	0.155	0.165
E	1.02	1.27	0.040	0.050

Part Number	Schematic Symbol	Polar	Device Marking Code	Reverse Stand-off Voltage	Reverse Leakage Current	Clamping Voltage (Tp=8/20us)	Peak Pulse Current (Tp=8/20us)	Off State Junction Capacitance
			$V_{RWM} (V)$	$V_{BR} (V)$	$I_R (\mu A)$	$V_C (V)$	$I_{pp} (A)$	$C_j (pF)$
SE8P40B2.8MA		Bi	2.8	3	1	15	24	3
SESLVU2.8-4		Bi	2.8	3	1	8.5	24	3
SESLVU2.8-8		Bi	2.8	3	0.5	20	25	3

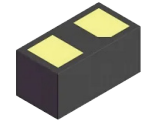

## DFN0603 PACKAGE INFORMATION

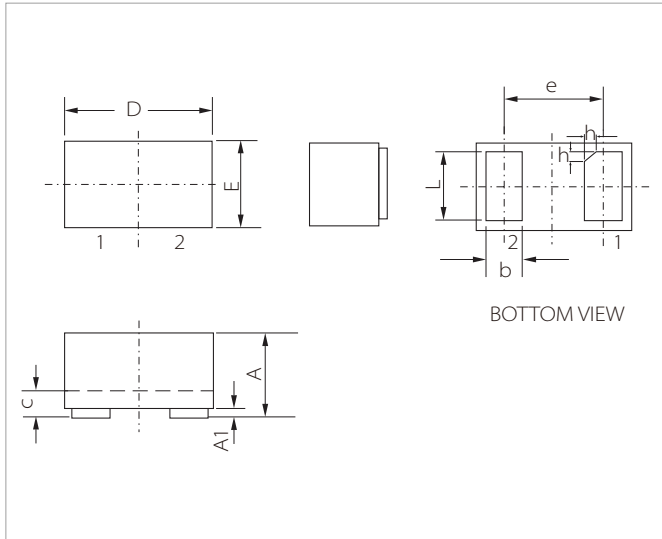



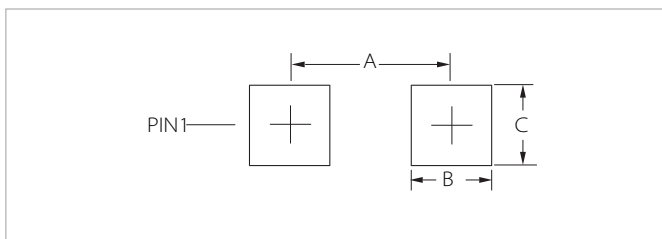

Ref.	Millimeters		Inches	
	Min.	Max.	Min.	Max.
A	0.28	0.34	0.011	0.014
A1	0	0.05	0	0.002
b	0.13	0.24	0.005	0.009
c	0.05	0.15	0.002	0.006
D	0.55	0.65	0.022	0.026
e	0.35BSC		0.014BSC	
E	0.25	0.35	0.010	0.014
L	0.20	0.30	0.008	0.012
h	0	0.10	0	0.004

## RECOMMENDED PAD LAYOUT DIMENSIONS



Ref.	Millimeters	Inches
A	0.38	0.015
B	0.23	0.009
C	0.30	0.012

Part Number	Schematic Symbol	Polar	Device Marking Code	Reverse Stand-off Voltage	Reverse Leakage Current	Clamping Voltage (Tp=8/20us)	Peak Pulse Current (Tp=8/20us)	Off State Junction Capacitance
			$V_{RWM}$ (V)	$V_{BR}$ (V)	$I_R$ (uA)	$V_C$ (V)	$I_{PP}$ (A)	$C_J$ (pF)
TPSE06F10B3.3MA		Bi	3.3	4.2	0.1	22	4	0.28
TPSE06F10B5.0MA		Bi	5	6	0.2	22	4	0.22
TPSE06F10B12LA		Bi	12	13.3	0.5	25	6	5
TPSE06F10B24LA		Bi	24	27.2	1	50	1	2.5
TPSE10F10B3.3A		Bi	3.3	3.5	0.5	10	8	12



## DFN1610P6 PACKAGE INFORMATION

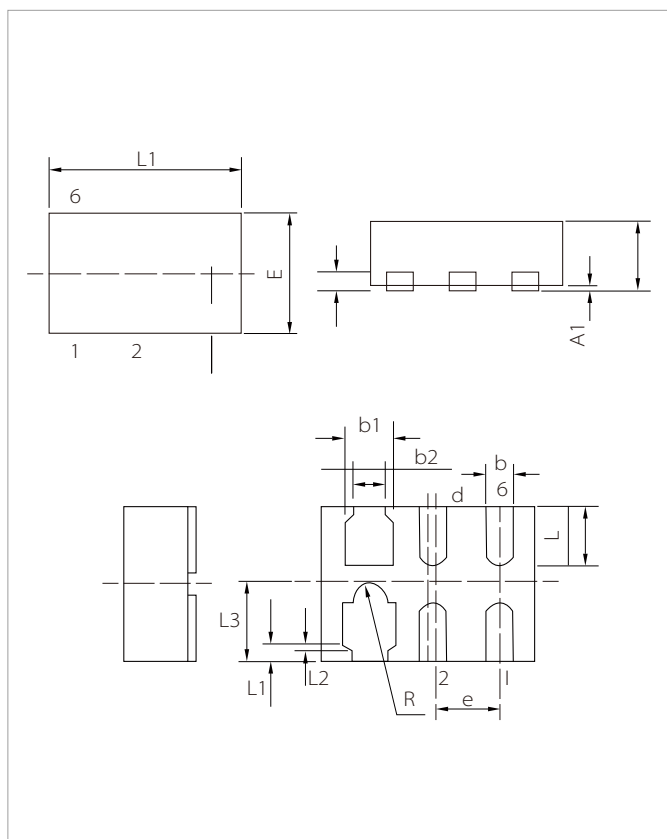

Ref.	Millimeters		Inches	
	Min.	Max.	Min.	Max.
A	0.45	0.55	0.018	0.022
A1	0	0.05	0	0.002
b	0.15	0.25	0.006	0.010
b1	0.35	0.45	0.014	0.018
b2	0.20	0.30	0.008	0.012
c	0.10	0.20	0.004	0.008
d	0.05TYP		0.002	
D	1.55	1.65	0.061	0.065
e	0.50BSC		0.020BSC	
E	0.95	1.05	0.037	0.041
L	0.30	0.45	0.012	0.018
L1	0.10REF		0.004REF	
L2	0.05REF		0.002REF	
L3	0.49REF		0.019REF	
R	0.08	0.18	0.003	0.007

## RECOMMENDED PAD LAYOUT DIMENSIONS

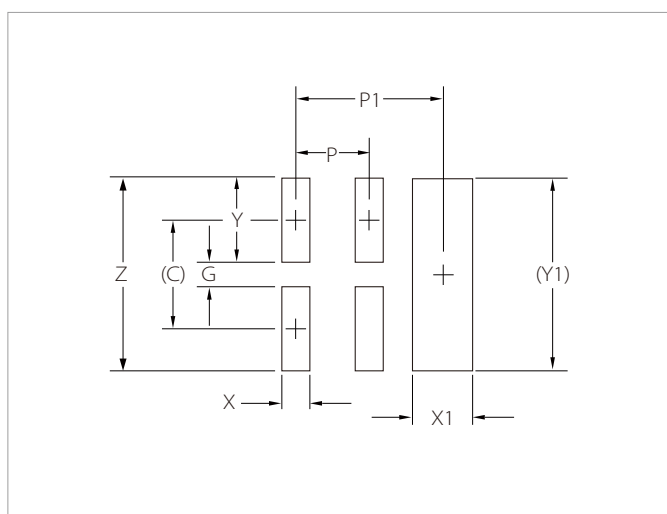

Ref.	Millimeters	Inches
C	0.875	0.034
G	0.20	0.008
P	0.50	0.020
P1	1.00	0.039
X	0.20	0.008
X1	0.40	0.016
Y	0.675	0.027
Y1	1.55	0.061
Z	1.55	0.061

Part Number	Schematic Symbol	Polar	Device Marking Code	Reverse Stand-off Voltage	Reverse Leakage Current	Clamping Voltage (Tp=8/20us)	Peak Pulse Current (Tp=8/20us)	Off State Junction Capacitance
			$V_{RWM}$ (V)	$V_{BR}$ (V)	$I_R$ (uA)	$V_C$ (V)	$I_{pp}$ (A)	$C_j$ (pF)
TPSE16P6F10B5.0MA		Bi	5	6	0.1	15	4	0.3

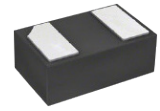

## DFN1006 PACKAGE INFORMATION

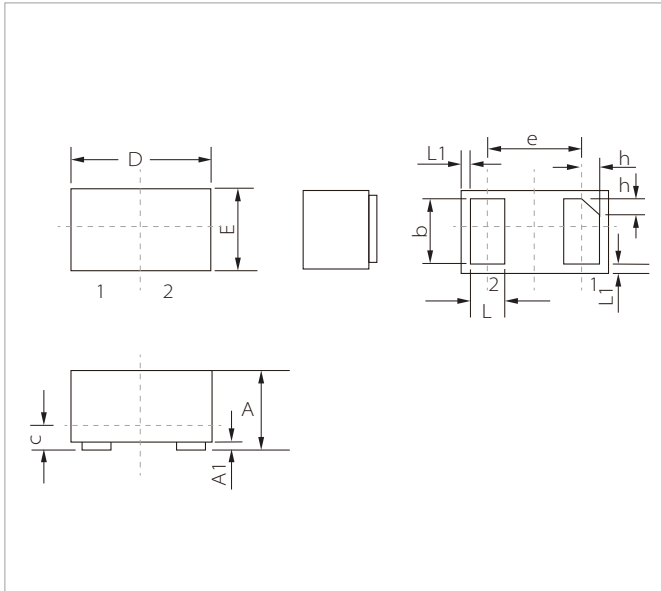

Ref.	Millimeters		Inches	
	Min.	Max.	Min.	Max.
A	0.35	0.50	0.014	0.020
A1	0	0.05	0	0.002
b	0.40	0.55	0.016	0.022
c	0.12	0.18	0.005	0.007
D	0.95	1.05	0.037	0.041
e	0.65BSC		0.026BSC	
E	0.55	0.70	0.022	0.027
L	0.20	0.35	0.008	0.014
L1	0.05REF		0.002REF	
h	0.07	0.17	0.003	0.007



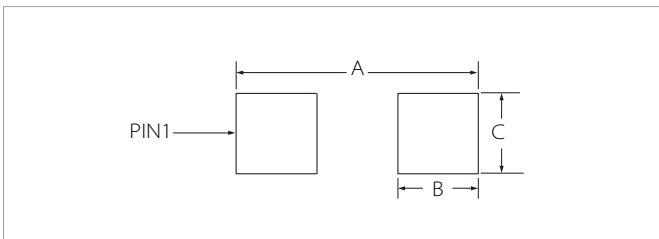

## RECOMMENDED PAD LAYOUT DIMENSIONS



Ref.	Millimeters	Inches
A	1.20	0.047
B	0.47	0.019
C	0.60	0.024

Part Number	Schematic Symbol	Polar	Device Marking Code	Reverse Stand-off Voltage	Reverse Leakage Current	Clamping Voltage (Tp=8/20us)	Peak Pulse Current (Tp=8/20us)	Off State Junction Capacitance
			$V_{RWM}(V)$	$V_{BR}(V)$	$I_R(\mu A)$	$V_C(V)$	$I_{PP}(A)$	$C_J(pF)$
TPSE10F10B5.0A		Bi	5	5.6	0.5	16.6	8.3	15
TPSE10F10B5.0MA		Bi	5	6	1	25	4	1
TPSE10F10U3.3MA		Uni	3.3	5	30	16	6	0.8
TPSE10F10U5.0MA		Uni	5	6	1	15	4	0.4
TPSE10F15B24A		Bi	24	26.7	0.1	5	3.5	11



Part Number	Schematic Symbol	Polar	Device Marking Code	Reverse Stand-off Voltage	Reverse Leakage Current	Clamping Voltage (Tp=8/20us)	Peak Pulse Current (Tp=8/20us)	Off State Junction Capacitance
			$V_{RWM}$ (V)	$V_{BR}$ (V)	$I_R$ (uA)	$V_C$ (V)	$I_{pp}$ (A)	$C_j$ (pF)
TPSE10F20B3.3A		Bi	3.3	3.5	1	12	15	50
TPSE10F20B8.0A		Bi	8	8.5	1	22	10	45
TPSE10F20B12A		Bi	12	15	0.1	19	8	8.5
TPSE10F20B36A		Bi	36	40	1	73	2.2	12
TPSE10F30B3.3A		Bi	3.3	3.4	0.5	12	25	50



## SOD-523 PACKAGE INFORMATION

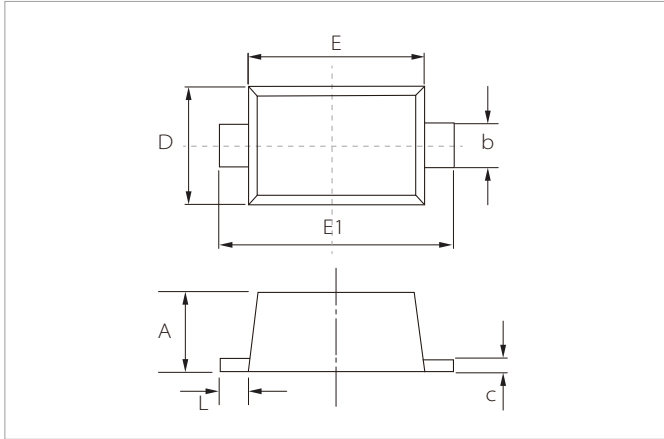

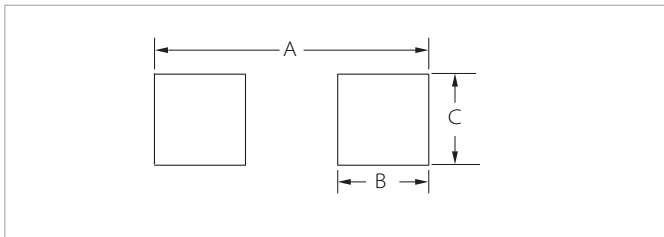

Ref.	Millimeters		Inches	
	Min.	Max.	Min.	Max.
A	0.50	0.80	0.020	0.031
b	0.25	0.35	0.010	0.014
c	0.07	0.20	0.003	0.008
D	0.70	0.90	0.028	0.035
E	1.10	1.30	0.043	0.051
E1	1.50	1.70	0.059	0.067
L	0.15	0.25	0.006	0.010

## RECOMMENDED PAD LAYOUT DIMENSIONS



Ref.	Millimeters		Inches	
	Min.	Min.	Min.	Min.
A	2.00		0.0787	
B	0.60		0.0236	
C	0.70		0.0276	

Part Number	Schematic Symbol	Polar	Device Marking Code	Reverse Stand-off Voltage	Reverse Leakage Current	Clamping Voltage (Tp=8/20us)	Peak Pulse Current (Tp=8/20us)	Off State Junction Capacitance
			$V_{RWM}$ (V)	$V_{BR}$ (V)	$I_R$ (uA)	$V_C$ (V)	$I_{PP}$ (A)	$C_j$ (pF)
TPSE5D10B3.3A		Bi	3.3	3.6	1	12	5	16.5
TPSE5D10B5.0A		Bi	5	6	1	25	5	15
TPSE5D20U5.0A		Uni	5	6	50	18.6	10	53.5

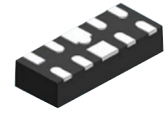

## DFN2510P10 PACKAGE INFORMATION

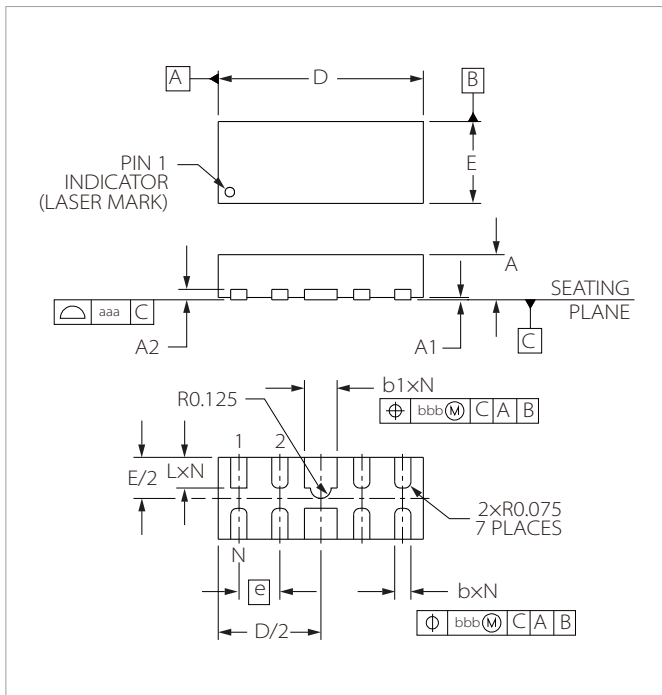

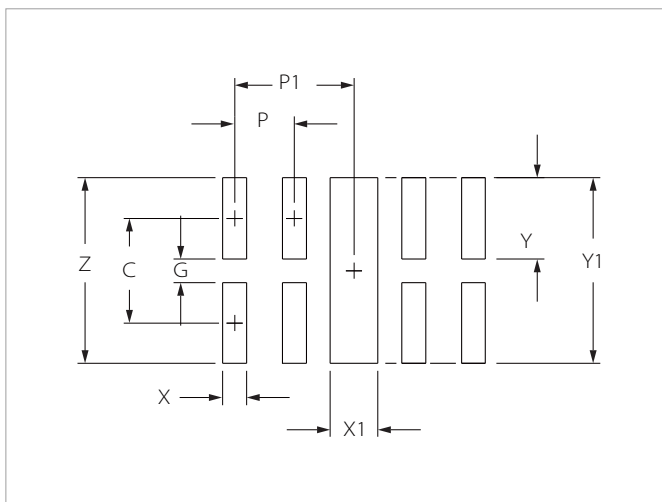

Ref.	Millimeters		Inches	
	Min.	Max.	Min.	Max.
A	0.40	0.65	0.016	0.026
A1	0	0.05	0	0.002
A2	(0.13)		(0.005)	
b	0.15	0.25	0.006	0.010
b1	0.35	0.45	0.014	0.018
D	2.40	2.60	0.094	0.102
E	0.90	1.10	0.035	0.043
e	0.50BSC		0.020BSC	
L	0.30	0.45	0.012	0.018
N	8		8	
aaa	0.08		0.003	
bbb	0.10		0.004	

## RECOMMENDED PAD LAYOUT DIMENSIONS



Ref.	Millimeters	Inches
C	0.87	0.034
G	0.20	0.008
P	0.50	0.020
P1	1.00	0.039
X	0.20	0.008
X1	0.40	0.016
Y	0.68	0.027
Y1	1.55	0.061
Z	1.55	0.061

Part Number	Schematic Symbol	Polar	Device Marking Code	Reverse Stand-off Voltage	Reverse Leakage Current	Clamping Voltage (Tp=8/20us)	Peak Pulse Current (Tp=8/20us)	Off State Junction Capacitance
			V <sub>RWM</sub> (V)	V <sub>BR</sub> (V)	I <sub>R</sub> (uA)	V <sub>C</sub> (V)	I <sub>pp</sub> (A)	C <sub>j</sub> (pF)
TPSEULC0524P		Uni	5	6	1	16	5	0.6

Part Number	Schematic Symbol	Polar	Device Marking Code	Reverse Stand-off Voltage	Reverse Leakage Current	Clamping Voltage (Tp=8/20us)	Peak Pulse Current (Tp=8/20us)	Off State Junction Capacitance
			$V_{RWM}$ (V)	$V_{BR}$ (V)	$I_R$ (uA)	$V_C$ (V)	$I_{pp}$ (A)	$C_j$ (pF)
TPSEULC0524PW		Uni	5	6	1	15	5	0.65
TPSEULC3304P		Uni	3.3	4	1	25	10	0.45



## SOT-363 PACKAGE INFORMATION

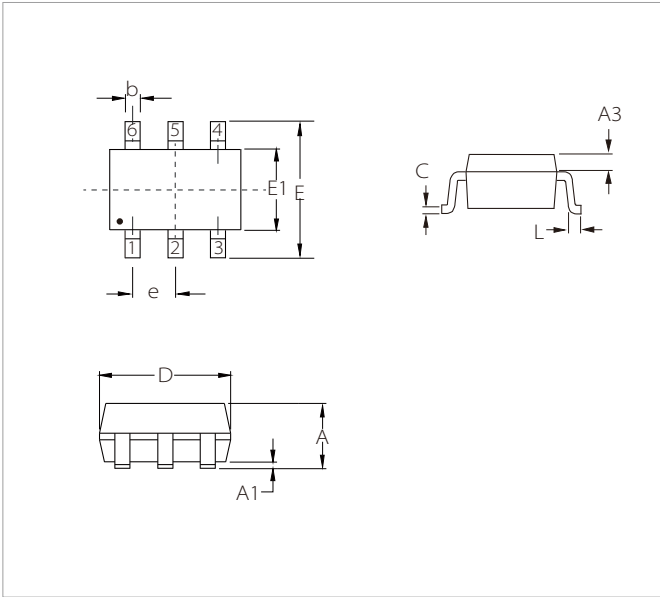

Ref.	Millimeters		Inches	
	Min.	Max.	Min.	Max.
A	0.800	1.100	0.031	0.043
A1	0.000	0.100	0.000	0.004
A3	0.20REF		0.008REF	
D	1.800	2.200	0.070	0.086
E1	1.150	1.350	0.045	0.053
E	2.000	2.200	0.078	0.086
e	0.65BSC		0.026BSC	
b	0.100	0.300	0.004	0.012
L	0.100	0.300	0.004	0.012
C	0.100	0.250	0.004	0.010

## RECOMMENDED PAD LAYOUT DIMENSIONS

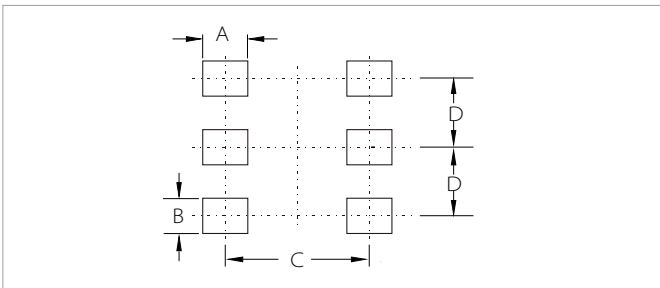

Ref.	Millimeters	Inches
A	0.50	0.0197
B	0.40	0.0157
C	1.90	0.0748
D	0.65	0.0250

Part Number	Schematic Symbol	Polar	Device Marking Code	Reverse Stand-off Voltage	Reverse Leakage Current	Clamping Voltage (Tp=8/20us)	Peak Pulse Current (Tp=8/20us)	Off State Junction Capacitance
			$V_{RWM}(V)$	$V_{BR}(V)$	$I_R(\mu A)$	$V_C(V)$	$I_{PP}(A)$	$C_j(pF)$
TPSE63T10U5.0E		Uni	5	6	1	15	8	60

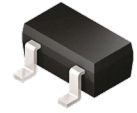

## SOT-323 PACKAGE INFORMATION

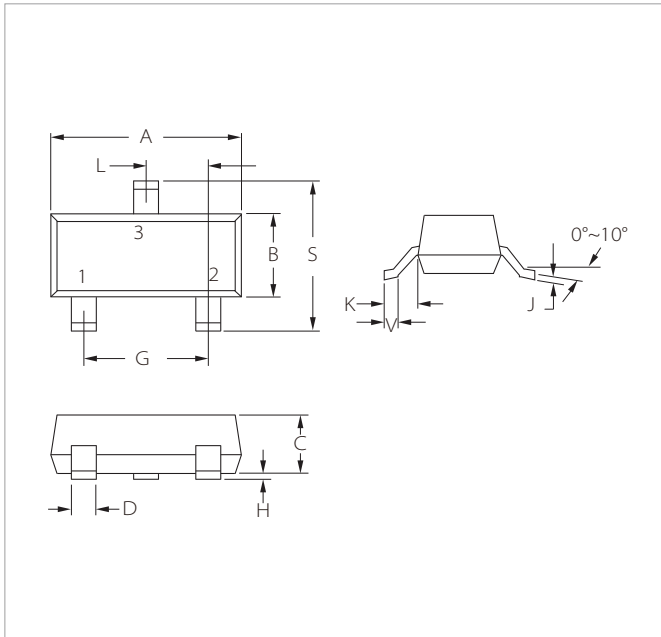

Ref.	Millimeters		Inches	
	Min.	Max.	Min.	Max.
A	2.00	2.20	0.079	0.087
B	1.15	1.35	0.045	0.053
C	0.90	1.00	0.035	0.039
D	0.20	0.40	0.008	0.016
G	1.20	1.40	0.047	0.055
H	0.00	0.10	0.000	0.004
J	0.08	0.15	0.003	0.006
K	0.525REF		0.021REF	
L	0.650TYP		0.026TYP	
S	2.15	2.45	0.085	0.096
V	0.26	0.46	0.010	0.018

## RECOMMENDED PAD LAYOUT DIMENSIONS

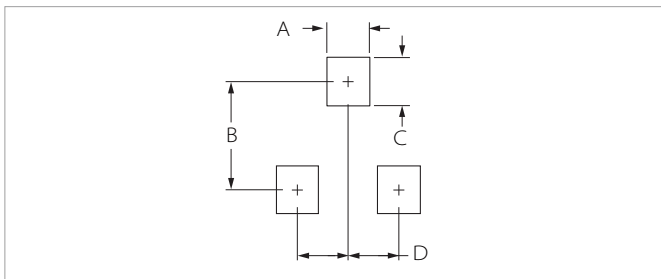

Ref.	Millimeters	Inches
	NOR	NOR
A	0.50	0.020
B	2.20	0.087
C	0.80	0.031
D	1.30	0.051

Part Number	Schematic Symbol	Polar	Device Marking Code	Reverse Stand-off Voltage	Reverse Leakage Current	Clamping Voltage (Tp=8/20us)	Peak Pulse Current (Tp=8/20us)	Off State Junction Capacitance
			$V_{RWM}$ (V)	$V_{BR}$ (V)	$I_R$ (uA)	$V_C$ (V)	$I_{pp}$ (A)	$C_j$ (pF)
TPSE33T25B24B		Bi	24	26.7	0.5	44	6	14



## SOD-323 PACKAGE INFORMATION

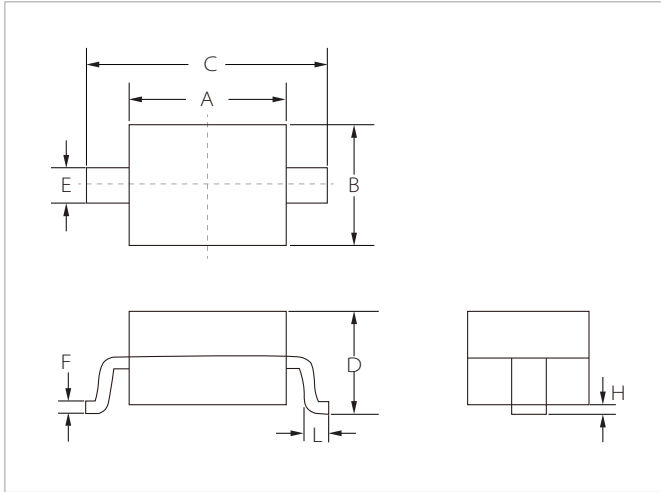





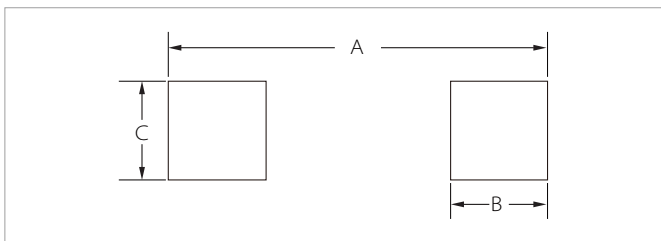



Ref.	Millimeters		Inches	
	Min.	Max.	Min.	Max.
A	1.60	1.90	0.063	0.075
B	1.15	1.45	0.045	0.057
C	2.39	2.75	0.094	0.108
D	0.80	1.10	0.031	0.043
E	0.25	0.40	0.010	0.016
F	0.10	0.20	0.004	0.008
H	-	0.10	-	0.004
L	0.20	0.40	0.008	0.016

## RECOMMENDED PAD LAYOUT DIMENSIONS



Ref.	Millimeters		Inches	
	Min.	Max.	Min.	Max.
A	2.87	3.12	0.113	0.123
B	0.66	0.91	0.026	0.036
C	0.66	0.91	0.026	0.036

Part Number	Schematic Symbol	Polar	Device Marking Code	Reverse Stand-off Voltage	Reverse Leakage Current	Clamping Voltage (Tp=8/20us)	Peak Pulse Current (Tp=8/20us)	Off State Junction Capacitance
			$V_{RWM}$ (V)	$V_{BR}$ (V)	$I_R$ (uA)	$V_C$ (V)	$I_{pp}$ (A)	$C_j$ (pF)
TPSE3D15B36MA		Bi	36	40	1	75	2	1
TPSE3D35B3.3MA		Bi	15	16.7	1	30	12	120
TPSE3D35B5.0A		Bi	5	5.5	0.2	25	20	39
TPSE3D35B5.0MA		Bi	5	6	0.2	25	14	1.5
TPSE3D35B24A		Bi	24	36.7	0.2	52	7	24
TPSE3D35B24MA		Bi	24	26.7	0.2	56	6	1

Part Number	Schematic Symbol	Polar	Device Marking Code	Reverse Stand-off Voltage	Reverse Leakage Current	Clamping Voltage (Tp=8/20us)	Peak Pulse Current (Tp=8/20us)	Off State Junction Capacitance
			$V_{RWM}$ (V)	$V_{BR}$ (V)	$I_R$ (uA)	$V_C$ (V)	$I_{pp}$ (A)	$C_j$ (pF)
TPSE3D35U5.0MA		Uni	5	6	0.1	25	13	1
TPSE3D35U24A		Uni	24	26.7	1	52	7	80
TPSE3D35B3.3MA		Bni	3.3	4.6	0.2	16	20	1





## SOT-23-5 PACKAGE INFORMATION

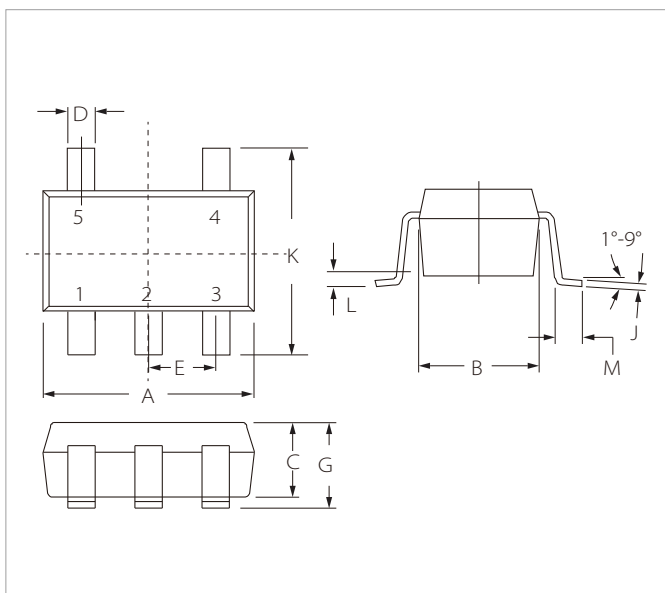

Ref.	Millimeters		Inches	
	Min.	Max.	Min.	Max.
A	2.80	3.10	0.110	0.122
B	1.50	1.80	0.059	0.071
C	0.90	1.30	0.036	0.051
D	0.25	0.50	0.010	0.020
E	0.95(Typ)		0.037(Typ)	
G	0.90	1.40	0.036	0.055
J	0.08	0.25	0.003	0.010
K	2.60	3.00	0.102	0.118
L	0.00	0.10	0.00	0.004
M	0.37	2.64	0.014	-

## RECOMMENDED PAD LAYOUT DIMENSIONS

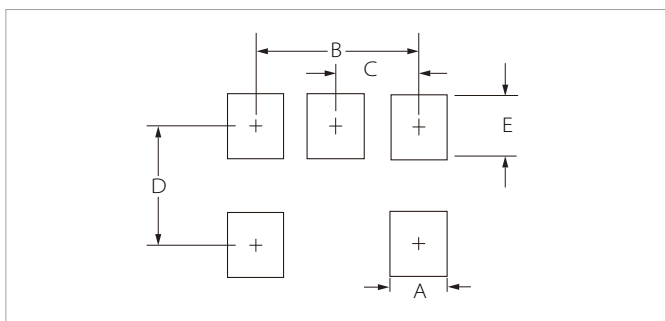

Ref.	Millimeters	Inches
	Nominal	Nominal
A	0.70	0.028
B	1.90	0.074
C	0.95	0.037
D	2.40	0.094
E	1.00	0.039

Part Number	Schematic Symbol	Polar	Device Marking Code	Reverse Stand-off Voltage	Reverse Leakage Current	Clamping Voltage (Tp=8/20us)	Peak Pulse Current (Tp=8/20us)	Off State Junction Capacitance
			$V_{RWM}(V)$	$V_{BR}(V)$	$I_R(\mu A)$	$V_C(V)$	$I_{PP}(A)$	$C_j(pF)$
TPSE25T10B5.0D		Bi	5	6	1	25	4	30

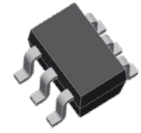

## SOT-23-6 PACKAGE INFORMATION

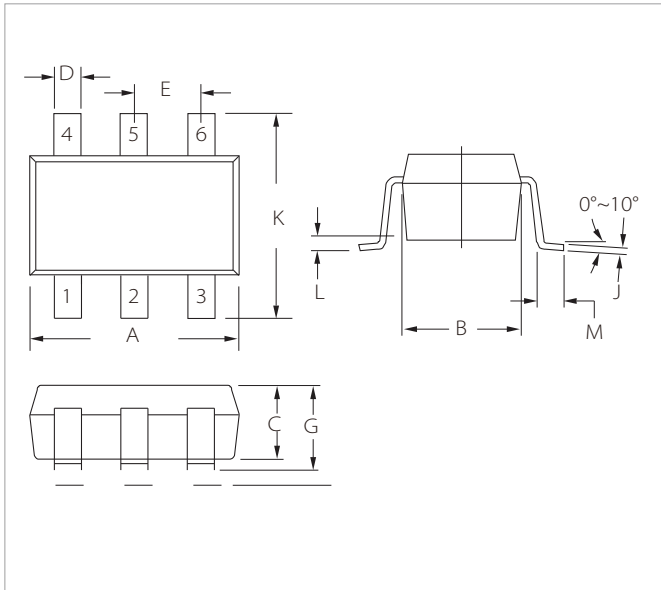

Ref.	Millimeters		Inches	
	Min.	Max.	Min.	Max.
A	2.70	3.05	0.106	0.120
B	1.30	1.80	0.052	0.071
C	0.90	1.30	0.036	0.051
D	0.20	0.50	0.008	0.020
E	0.85	1.05	0.033	0.040
G	0.90	1.45	0.036	0.057
J	0.09	0.20	0.003	0.008
K	2.50	3.10	0.099	0.122
L	0.0	0.15	0.0	0.006
M	0.30	0.60	0.012	0.024

## RECOMMENDED PAD LAYOUT DIMENSIONS

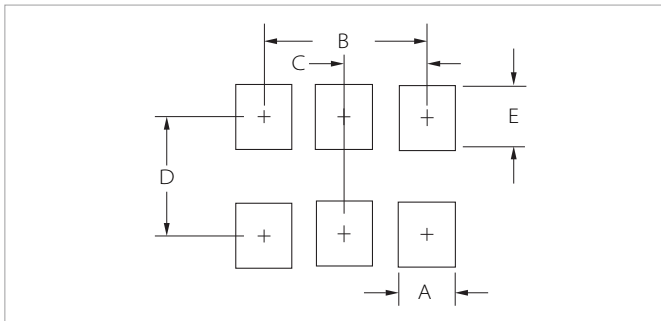

Ref.	Millimeters	Inches
	Nominal	Nominal
A	0.70	0.028
B	1.90	0.074
C	0.95	0.037
D	2.40	0.094
E	1.00	0.039

Part Number	Schematic Symbol	Polar	Device Marking Code	Reverse Stand-off Voltage	Reverse Leakage Current	Clamping Voltage (Tp=8/20us)	Peak Pulse Current (Tp=8/20us)	Off State Junction Capacitance
			$V_{RWM}(V)$	$V_{BR}(V)$	$I_R(\mu A)$	$V_C(V)$	$I_{PP}(A)$	$C_j(pF)$
TPSE26T15U24A		Uni	24	29.7	0.1	45	3.4	23
TPSESRV05-4		Uni	5	6	1	17.5	5	0.3



## SOT-23 PACKAGE INFORMATION

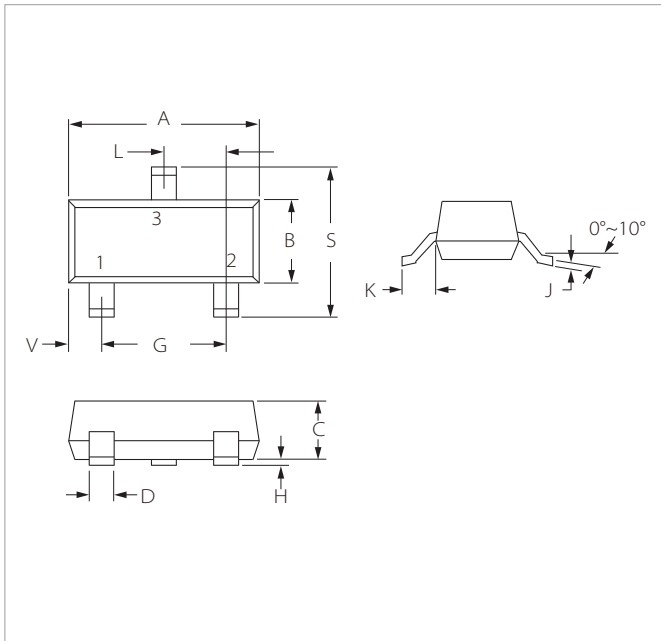



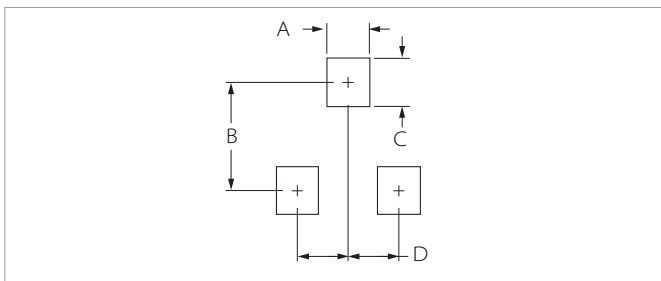

Ref.	Millimeters		Inches	
	Min.	Max.	Min.	Max.
A	2.80	3.04	0.110	0.120
B	1.20	1.40	0.047	0.055
C	0.89	1.11	0.035	0.044
D	0.37	0.50	0.015	0.020
G	1.78	2.04	0.070	0.081
H	0.01	0.100	0.001	0.004
J	0.085	0.180	0.003	0.007
K	0.35	0.69	0.014	0.029
L	0.89	1.02	0.035	0.040
S	2.10	2.64	0.083	0.104
V	0.45	0.60	0.018	0.024

## RECOMMENDED PAD LAYOUT DIMENSIONS



Ref.	Millimeters		Inches	
	Min.	Max.	Min.	Max.
A	0.71	0.97	0.028	0.038
B	1.88	2.13	0.074	0.084
C	0.71	0.97	0.028	0.038
D	0.81	1.07	0.032	0.042

Part Number	Schematic Symbol	Polar	Device Marking Code	Reverse Stand-off Voltage	Reverse Leakage Current	Clamping Voltage (Tp=8/20us)	Peak Pulse Current (Tp=8/20us)	Off State Junction Capacitance
			$V_{RWM}$ (V)	$V_{BR}$ (V)	$I_R$ (uA)	$V_C$ (V)	$I_{pp}$ (A)	$C_j$ (pF)
TPSE23T10B5.0UB		Bi	5	8.5	0.1	25	4	0.6
TPSE23T20B24LB		Bi	24	26	1	50	3	13
TPSE23T35B3.0B		Bi	3.3	4	40	13	20	450

Part Number	Schematic Symbol	Polar	Device Marking Code	Reverse Stand-off Voltage	Reverse Leakage Current	Clamping Voltage (Tp=8/20us)	Peak Pulse Current (Tp=8/20us)	Off State Junction Capacitance
			$V_{RWM}$ (V)	$V_{BR}$ (V)	$I_R$ (uA)	$V_C$ (V)	$I_{pp}$ (A)	$C_j$ (pF)
TPSE23T35B24B		Bi	24	26.7	1	52	7	50
TPSE23T35B36B		Bi	36	40	1	75	5	18
TPSE23T35U24B		Uni	24	26.7	1	52	6	90
TPSE23T40B712B		Bi	12	13.3	1	26	17	55



Build Your Design As You Will



Technical support: 400-021-5756  
[Http://www.semiware.com](http://www.semiware.com)

