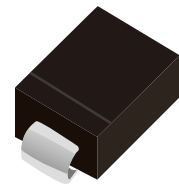
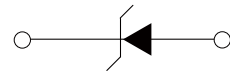


## FEATURES

- | The plastic package carries Underwriters Laboratory Flammability Classification 94V-0
- | For surface mounted applications
- | Built-in strain relief, ideal for automated placement
- | Low reverse leakage
- | High forward surge current capability
- | High temperature soldering guaranteed 260°C/10 seconds at terminals



DO-214AA(SMB)



Schematic Symbol

## APPLICATIONS

- | Case : Molded plastic body
- | Polarity : Polarity symbol marking on body
- | Mounting Position : Any

## APPROVALS

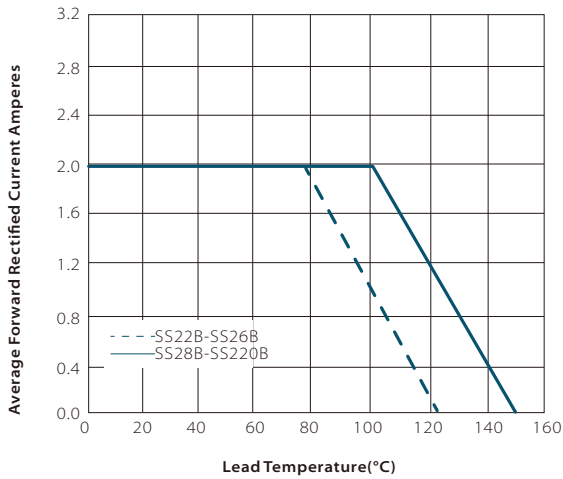
|             |                                    |
|-------------|------------------------------------|
| <b>RoHS</b> | Compliance with 2011/65/EU         |
| <b>HF</b>   | Compliance with IEC61249-2-21:2003 |

## MAXIMUM RATINGS (T<sub>A</sub>=25°C )

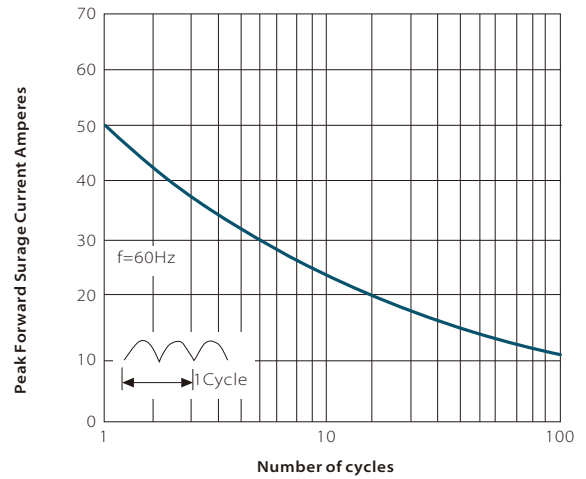
| Parameter  | Symbol                | SS22B       | SS24B | SS25B | SS26B | SS28B       | SS210B | SS215B | SS220B | Unit |
|--|-----------------------|-------------|-------|-------|-------|-------------|--------|--------|--------|------|
| Marking  |                       | SS22        | SS24  | SS25  | SS26  | SS28        | SS210  | SS215  | SS220  |      |
| Maximum repetitive peak reverse voltage  | V <sub>RRM</sub>      | 20          | 40    | 50    | 60    | 80          | 100    | 150    | 200    | V    |
| Maximum RMS voltage  | V <sub>RMS</sub>      | 14          | 28    | 35    | 42    | 56          | 70     | 105    | 140    | V    |
| Maximum DC blocking voltage  | V <sub>DC</sub>       | 20          | 40    | 50    | 60    | 80          | 100    | 150    | 200    | V    |
| Maximum average forward rectified current at T <sub>L</sub> =100 C                 | I <sub>(AV)</sub>     | 2.0         |       |       |       |             |        |        |        | A    |
| Peak forward surge current, 8.3ms single half sine-wave superimposed on rated load | I <sub>FSM</sub>      | 50          |       |       |       |             |        |        |        | A    |
| Maximum instantaneous forward voltage at 2.0A                                      | V <sub>F</sub>        | 0.55        |       |       | 0.70  | 0.85        |        | 0.95   |        | V    |
| Maximum DC reverse current at rated DC blocking voltage                            | T <sub>A</sub> =25°C  | 0.2         |       |       |       | 0.05        |        |        |        | uA   |
|  | T <sub>A</sub> =100°C | 10          |       |       |       | 5           |        |        |        | uA   |
| Typical thermal resistance   | R <sub>θJA</sub>      | 60          |       |       |       |             |        |        |        | °C/W |
| Operating junction temperature range   | T <sub>J</sub>        | -55 to +125 |       |       |       | -55 to +150 |        |        |        | °C   |
| Storage temperature range  | T <sub>STG</sub>      | -55 to +150 |       |       |       |             |        |        |        | °C   |

# CHARACTERISTIC CURVES

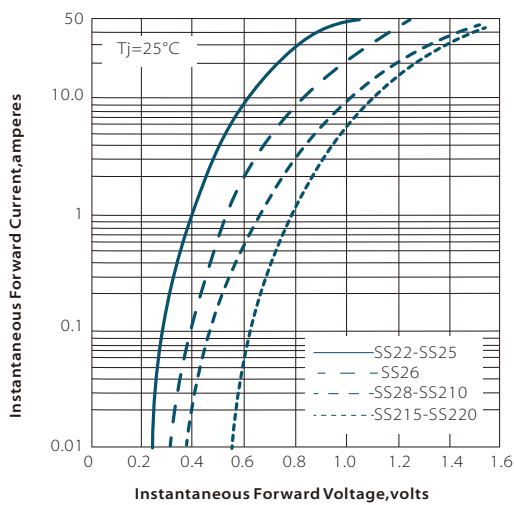
**Fig. 1- Derating Curve Output Rectified Current**



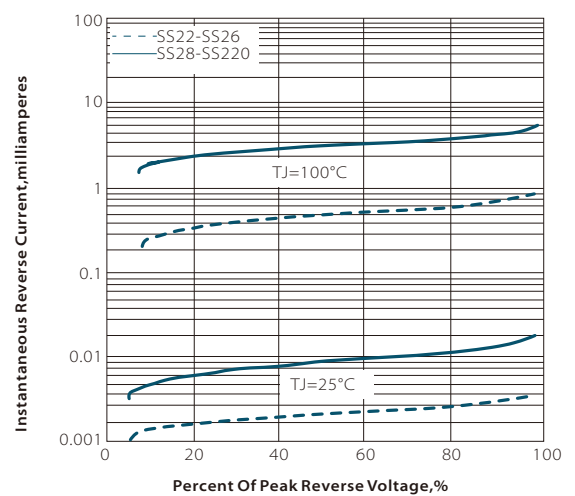
**Fig. 2-maximum Non-repetitive Peak Forward Surge Current Perleg**



**Fig. 3-typical Forward Voltage Characteristics**

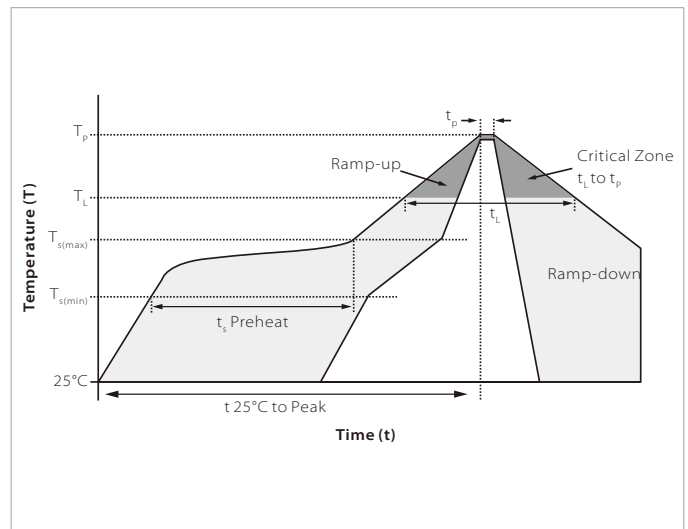


**Fig. 4-typical Reverse Leakage Characteristics**

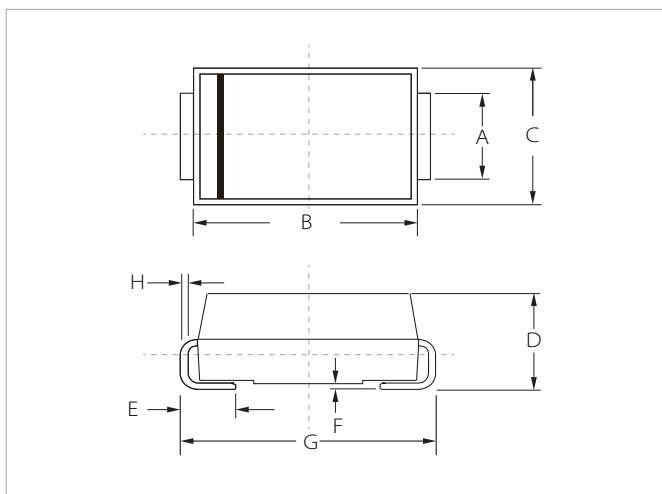


## SOLDERING PARAMETERS

| Reflow Condition                                       |                                  | Lead-free assembly |
|--|----------------------------------|--------------------|
| Pre Heat   | Temperature Max ( $T_{s(min)}$ ) | 150°C              |
|  | Temperature Max ( $T_{s(max)}$ ) | 200°C              |
|  | Time (min to max) ( $t_2$ )      | 60 – 180 secs      |
| Average ramp up rate (Liquidus Temp ( $T_L$ ) to peak) |                                  | 3°C/second max     |
| $T_{s(max)}$ to $T_L$ - Ramp-up Rate                   |                                  | 3°C/second max     |
| Reflow   | Temperature ( $T_L$ ) (Liquidus) | 217°C              |
|  | Time (min to max) ( $t_1$ )      | 60 – 150 seconds   |
| Peak Temperature ( $T_p$ )                             |                                  | 260°C              |
| Time within 5°C of actual peak Temperature ( $t_p$ )   |                                  | 20 – 40 seconds    |
| Ramp-down Rate   |                                  | 6°C/second max     |
| Time 25°C to peak Temperature ( $T_p$ )                |                                  | 8 minutes max.     |
| Do not exceed  |                                  | 260°C              |

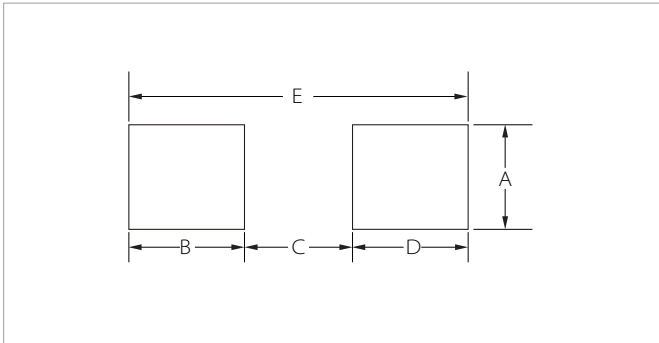


## DO-214AA(SMB) PACKAGE INFORMATION



| Ref. | Millimeters |      | Inches |       |
|------|-------------|------|--------|-------|
|      | Min.        | Max. | Min.   | Max.  |
| A    | 1.80        | 2.20 | 0.071  | 0.087 |
| B    | 4.30        | 4.70 | 0.170  | 0.185 |
| C    | 3.40        | 3.90 | 0.134  | 0.153 |
| D    | 2.15        | 2.55 | 0.085  | 0.100 |
| E    | 1.00        | 1.50 | 0.039  | 0.059 |
| F    | 0.02        | 0.20 | 0.001  | 0.008 |
| G    | 5.10        | 5.50 | 0.200  | 0.216 |
| H    | 0.15        | 0.30 | 0.006  | 0.012 |

## RECOMMENDED PAD LAYOUT DIMENSIONS



| Ref. | Millimeters |      | Inches   |       |
|------|-------------|------|----------|-------|
|      | Min.        | Max. | Min.     | Max.  |
| A    | 2.20        | -    | 0.087    | -     |
| B    | 1.45        | -    | 0.057    | -     |
| C    | -           | 2.55 | -        | 0.010 |
| D    | 1.45        | -    | 0.057    | -     |
| E    | 5.60REF     |      | 0.220REF |       |

## ORDERING INFORMATION

| Part Number  | Component Package | QTY/Reel | Reel Size |
|--------------|-------------------|----------|-----------|
| SS22B-SS220B | DO-214AA(SMB)     | 3000PCS  | 13"       |

To find your local partner within Semiwell's website : [www.semiwell.com.cn](http://www.semiwell.com.cn)

© 2023 Semiwell Microelectronics Co.,Ltd.

The content of this document has been carefully checked and understood. However, neither Semiwell nor its subsidiaries assume any liability whatsoever for any errors or inaccuracies of this document and the consequences thereof. Published specifications are subject to change without notice. Product suitability for any area of application must ultimately be determined by the customer. In all cases, products must never be operated outside their published specifications. Semiwell does not guarantee the availability of all published products. This disclaimer shall be governed by substantive Chinese law and resulting disputes shall be settled by the courts at the place of business of Semiwell. Latest publications and a complete disclaimer can be downloaded from the Semiwell website. All trademarks recognized.