

FEATURES

- | Excellent capability of absorbing transient surge
- | Quick response to surge voltage
- | Eliminates over voltage caused by fast rising transients
- | Solid-state silicon technology, non degenerate

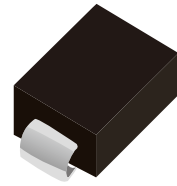

SMB(DO-214AA)



Marking



Schematic Symbol

APPLICATIONS

- | Audio/Video line
- | Network and telecom
- | Data lines and security systems
- | Serial ports

APPROVALS

RoHS	Compliance with 2011/65/EU
HF	Compliance with IEC61249-2-21:2003

ELECTRICAL CHARACTERISTICS

Part Number	V_{DRM}	V_S	V_T	I_{DRM}	I_S	I_T	I_H	C_o
	Min. (V)	Max. (V)	Max. (V)	Max. (μ A)	mA	Max. (A)	Min. (mA)	Typ.(pF)
P0080SB-MC	6.0	25.0	4.0	5.0	800.0	2.2	40.0	20.0

SURGE RATINGS

Part Number	I_{PP} 2x10us	I_{PP} 8x20us	I_{PP} 10x560us	I_{PP} 10x1000us	V_{PP} 10x700us	I_{TSM} 50/60Hz	d_i/d_t
	(A)	(A)	(A)	(A)	(V)	(A)	(A/us)
P0080SB-MC	250	250	100	80	4000	25	500

THERMAL CONSIDERATIONS

Symbol	Parameter	Value	Unit
$R_{\theta JA}$	Junction to Ambient on printed circuit	90	°C/W
T_J	Operating Junction Temperature	-55 to +125	°C
T_{STG}	Storage Temperature Range	-55 to +150	°C

RATINGS AND CHARACTERISTIC CURVES ($T_A=25^\circ\text{C}$)

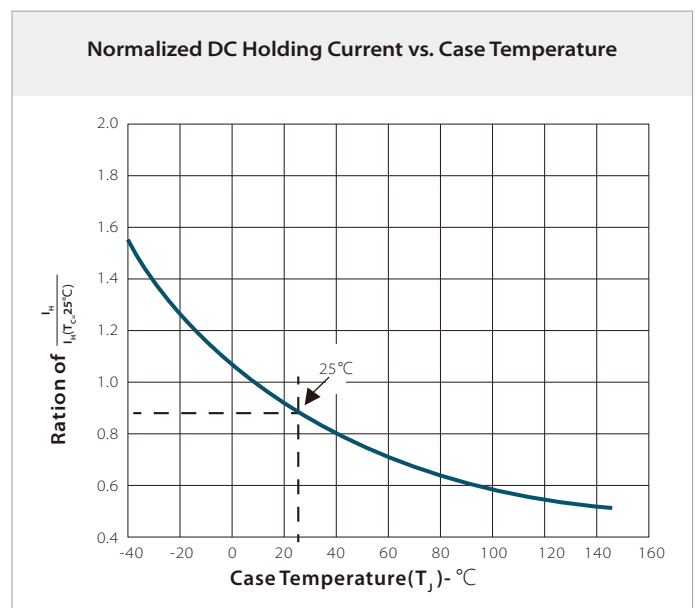
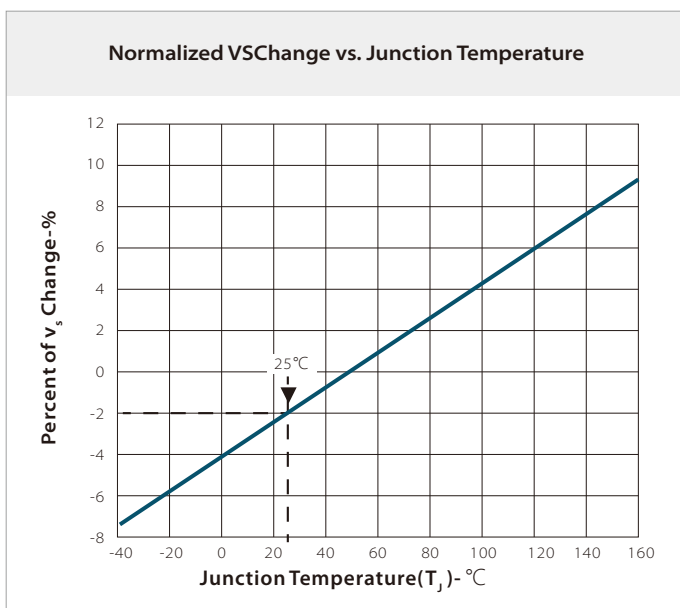
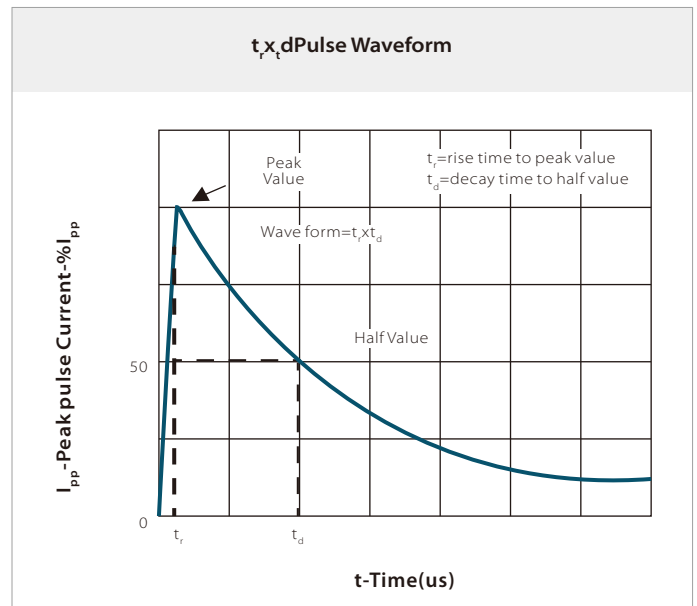
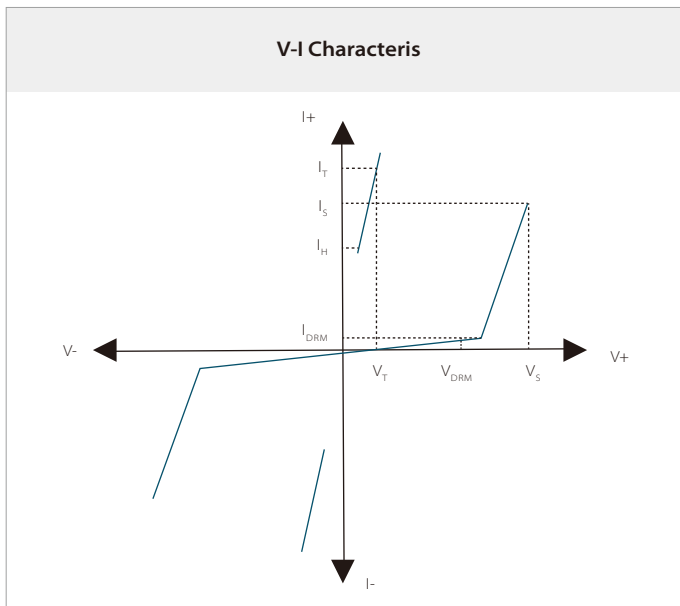

SOLDERING PARAMETERS

Reflow Condition		Lead-free assembly
Pre Heat	Temperature Max ($T_{s(min)}$)	150°C
	Temperature Max ($T_{s(max)}$)	200°C
	Time (min to max) (t_2)	60 – 180 secs
Average ramp up rate (Liquidus Temp (T_L) to peak		3°C/second max
$T_{s(max)}$ to T_L - Ramp-up Rate		3°C/second max
Reflow	Temperature (T_L) (Liquidus)	217°C
	Time (min to max) (t_1)	60 – 150 seconds
Peak Temperature (T_p)		260°C
Time within 5°C of actual peak Temperature (t_p)		20 – 40 seconds
Ramp-down Rate		6°C/second max
Time 25°C to peak Temperature (T_p)		8 minutes max.
Do not exceed		260°C

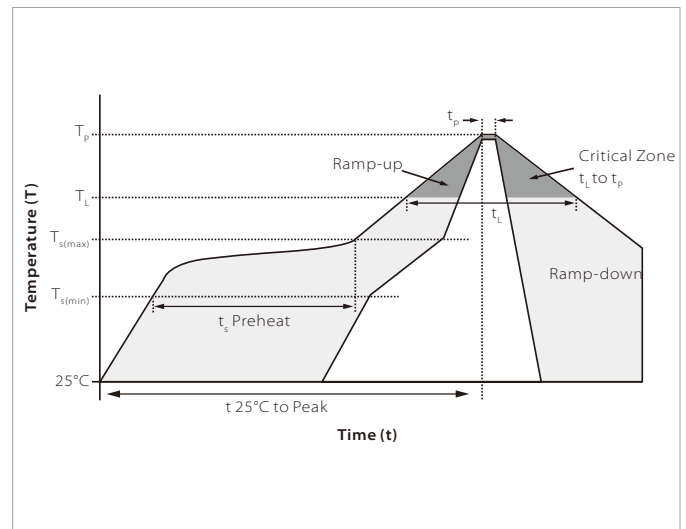

DO-214AA(SMB) PACKAGE INFORMATION

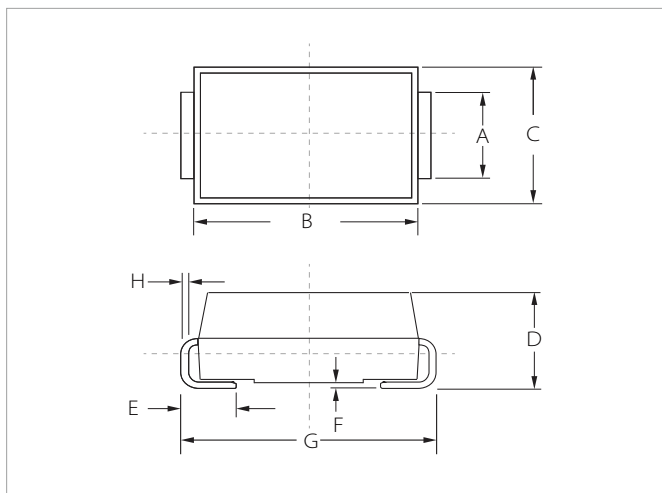

Ref.	Millimeters		Inches	
	Min.	Max.	Min.	Max.
A	1.80	2.20	0.071	0.087
B	4.30	4.70	0.170	0.185
C	3.40	3.90	0.134	0.153
D	2.15	2.55	0.085	0.100
E	1.00	1.50	0.039	0.059
F	0.02	0.20	0.001	0.008
G	5.10	5.50	0.200	0.216
H	0.15	0.30	0.006	0.012

RECOMMENDED PAD LAYOUT DIMENSIONS

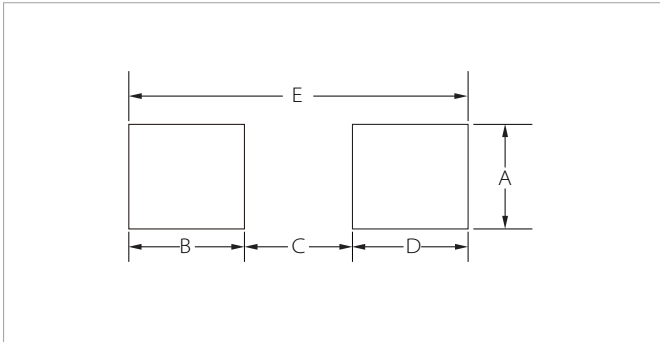

Ref.	Millimeters		Inches	
	Min.	Max.	Min.	Max.
A	2.20	-	0.087	-
B	1.45	-	0.057	-
C	-	2.55	-	0.010
D	1.45	-	0.057	-
E	5.60REF		0.220REF	

ORDERING INFORMATION

Part Number	Component Package	QTY/Reel	Reel Size
P0080SB-MC	DO-214AA(SMB)	3000PCS	13"

To find your local partner within Semiwell' s website : www.semiwell.com.cn

© 2023 Semiwell Microelectronics Co.,Ltd.

The content of this document has been carefully checked and understood. However, neither Semiwell nor its subsidiaries assume any liability whatsoever for any errors or inaccuracies of this document and the consequences thereof. Published specifications are subject to change without notice. Product suitability for any area of application must ultimately be determined by the customer. In all cases, products must never be operated outside their published specifications. Semiwell does not guarantee the availability of all published products. This disclaimer shall be governed by substantive Chinese law and resulting disputes shall be settled by the courts at the place of business of Semiwell. Latest publications and a complete disclaimer can be downloaded from the Semiwell website. All trademarks recognized.