

FEATURES

- | Power dissipation of 200mW

- | High stability and high reliability

MECHANICAL DATA

- | SOT-23 small outline plastic package

- | Epoxy UL: 94V-0

- | Mounting position: Any

APPROVALS

RoHS	Compliance with 2011/65/EU
HF	Compliance with IEC61249-2-21:2003

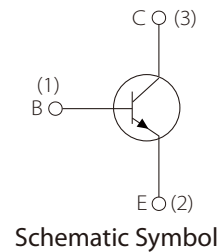
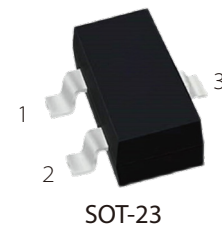

MAXIMUM RATINGS (T_A = 25°C)

Parameter	Symbol	Value	Unit
Collector-Base Voltage	V _{CBO}	60	V
Collector-Emitter Voltage	V _{CEO}	40	
Emitter-Base Voltage	V _{EBO}	6	
Collector Current	I _C	200	mA
Collector Power Dissipation	P _C	200	mW
Thermal Resistance From Junction To Ambient	R _{θJA}	625	°C/W
Operation Junction and Storage Temperature Range	T _J , T _{STG}	-55~+150	°C

ELECTRICAL CHARACTERISTICS (T_A=25°C)

Parameter	Symbol	Test Conditions	Min.	Typ.	Max.	Unit
Collector-base breakdown voltage	V _{(BR)CBO}	I _C =10μA, I _E =0	60			V
Collector-emitter breakdown voltage	V _{(BR)CEO}	I _C =1mA, I _B =0	40			
Emitter-base breakdown voltage	V _{(BR)EBO}	I _E =10μA, I _C =0	6			
Collector cut-off current	I _{CEX}	V _{CE} =30V, V _{EB(off)} =3V			50	nA
Collector cut-off current	I _{CBO}	V _{CB} =60V, I _E =0			100	
Emitter cut-off current	I _{EBO}	V _{EB} =5V, I _C =0			100	
DC current gain	h _{FE(1)}	V _{CE} =1V, I _C =10mA		100	300	
	h _{FE(2)}	V _{CE} =1V, I _C =50mA		60		
	h _{FE(3)}	V _{CE} =1V, I _C =100mA		30		
Collector-emitter saturation voltage	V _{CE(sat)}	I _C =50mA, I _B =5mA			0.3	V
Base-emitter saturation voltage	V _{BE(sat)}	I _C =50mA, I _B =5mA			0.95	
Transition frequency	f _T	V _{CE} =20V, I _C =10mA, f=100MHz		300		MHz
Delay time	t _d	V _{CC} =3V, V _{BE(off)} =-0.5V, I _C =10mA, I _{B1} =1mA			35	nS
Rise time	t _r	V _{CC} =3V, V _{BE(off)} =-0.5V, I _C =10mA, I _{B1} =1mA			35	
Storage time	t _s	V _{CC} =3V, I _C =10mA, I _{B1} =I _{B2} =1mA			200	
Fall time	t _f	V _{CC} =3V, I _C =10mA, I _{B1} =I _{B2} =1mA			50	

CLASSIFICATION OF H_{FE(1)}

HFE	100-300	
Rank	L	H
Range	100-200	200-300

TYPICAL CHARACTERISTICS

Static Characteristic

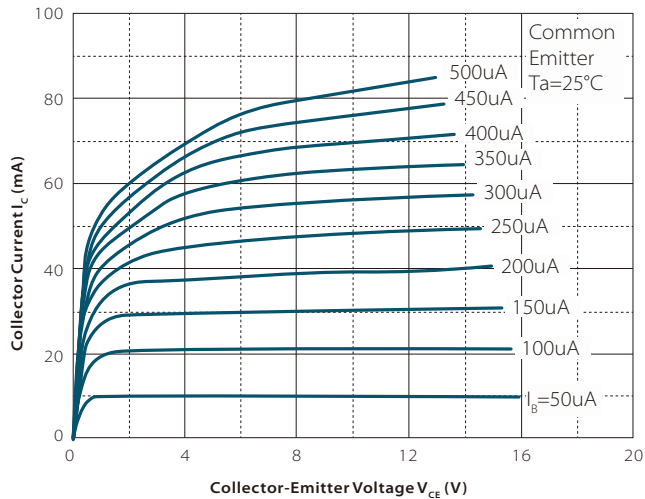

h_{FE} ——— I_C

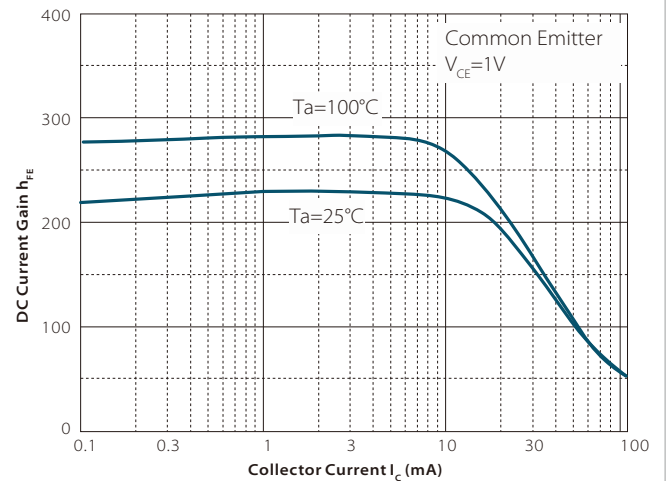

V_{CEsat} ——— I_C

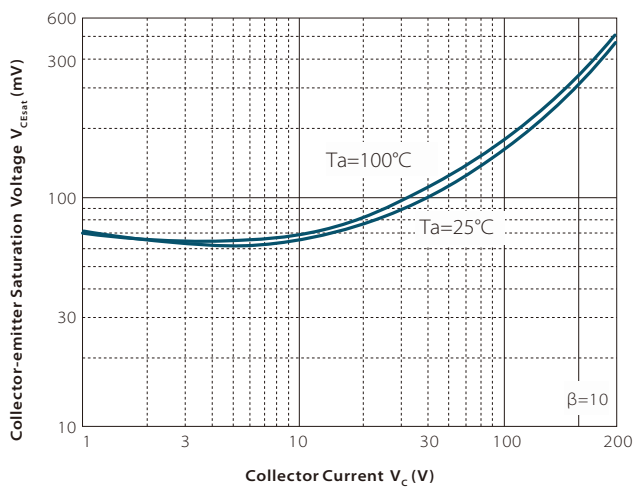

V_{CEsat} ——— I_C

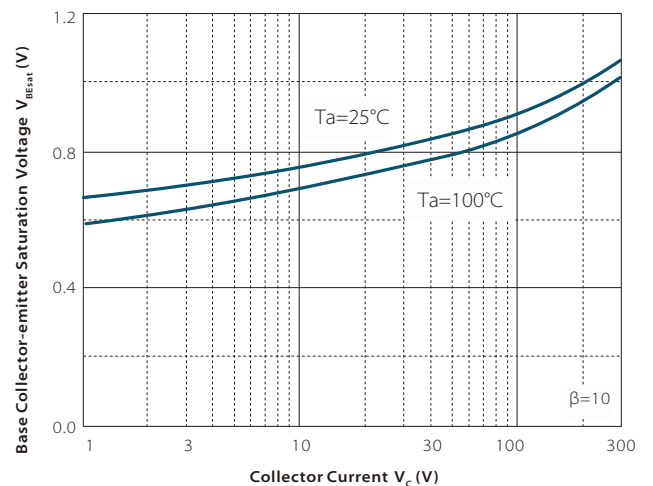

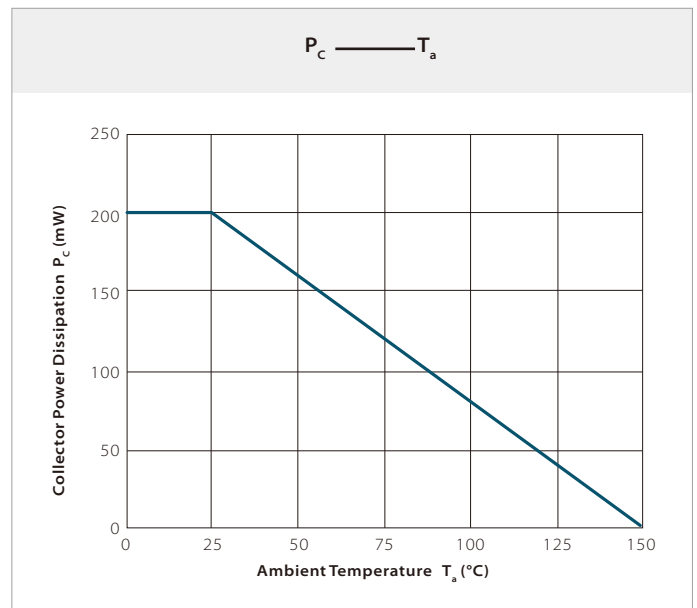
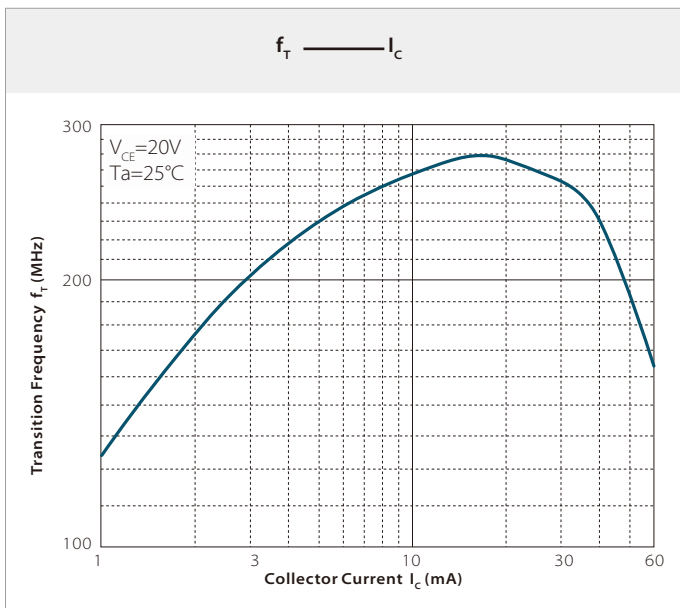
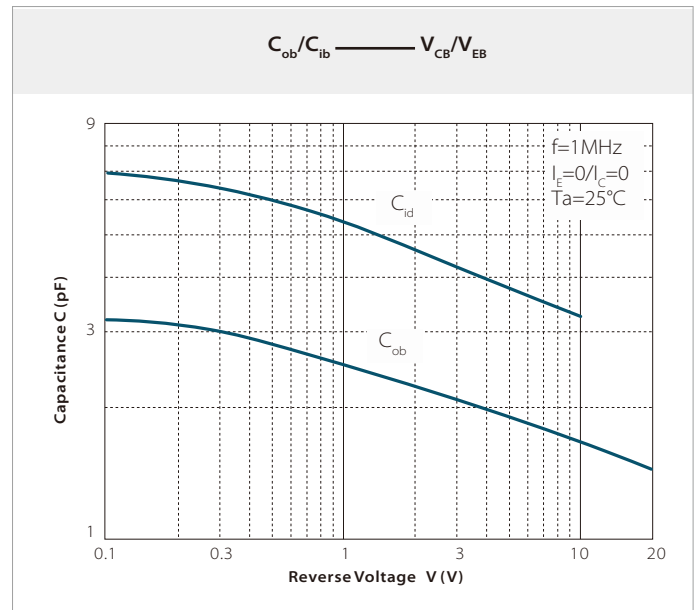
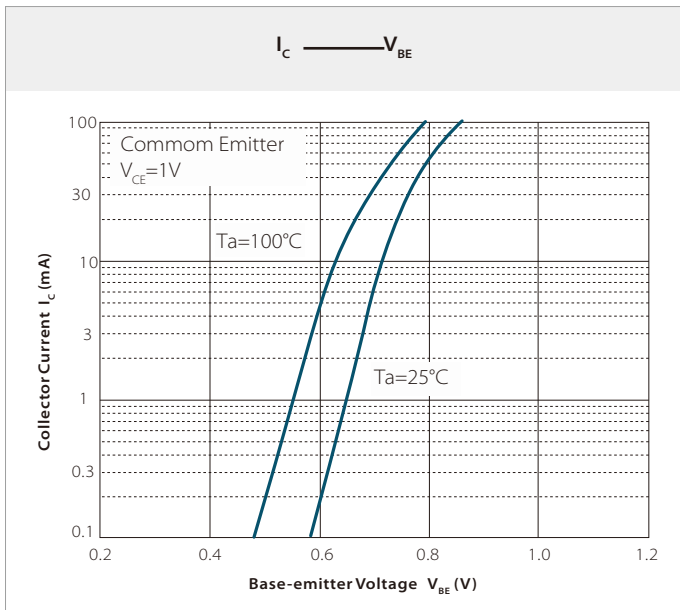

SOT-23 PACKAGE INFORMATION

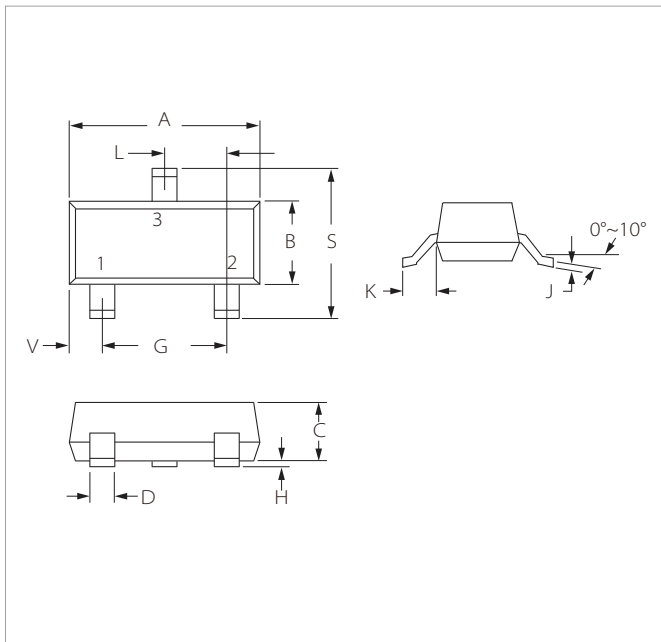

Ref.	Millimeters		Inches	
	Min.	Max.	Min.	Max.
A	2.80	3.04	0.110	0.120
B	1.20	1.40	0.047	0.055
C	0.89	1.11	0.035	0.044
D	0.37	0.50	0.015	0.020
G	1.78	2.04	0.070	0.081
H	0.01	0.100	0.001	0.004
J	0.085	0.180	0.003	0.007
K	0.35	0.69	0.014	0.029
L	0.89	1.02	0.035	0.040
S	2.10	2.64	0.083	0.104
V	0.45	0.60	0.018	0.024

RECOMMENDED PAD LAYOUT DIMENSIONS

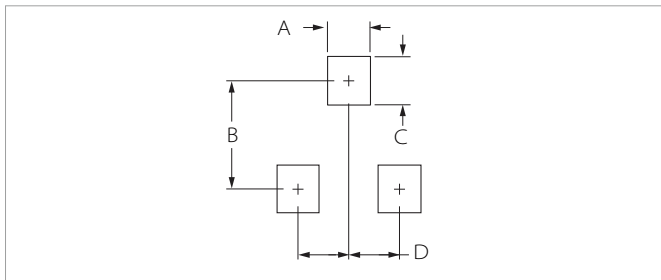

Ref.	Millimeters		Inches	
	Min.	Max.	Min.	Max.
A	0.71	0.97	0.028	0.038
B	1.88	2.13	0.074	0.084
C	0.71	0.97	0.028	0.038
D	0.81	1.07	0.032	0.042

ORDERING INFORMATION

Part Number	Component Package	QTY/Reel	Reel Size
MMBT3904	SOT-23	3000PCS	7"

To find your local partner within Semiwell's website : www.semiwell.com.cn

©2023 Semiwell Microelectronics Co.,Ltd.

The content of this document has been carefully checked and understood. However, neither Semiwell nor its subsidiaries assume any liability whatsoever for any errors or inaccuracies of this document and the consequences thereof. Published specifications are subject to change without notice. Product suitability for any area of application must ultimately be determined by the customer. In all cases, products must never be operated outside their published specifications. Semiwell does not guarantee the availability of all published products. This disclaimer shall be governed by substantive Chinese law and resulting disputes shall be settled by the courts at the place of business of Semiwell. Latest publications and a complete disclaimer can be downloaded from the Semiwell website. All trademarks recognized.