

FEATURES

- | High voltage capability
- | Planar passivated for voltage ruggedness and reliability
- | Sensitive gate

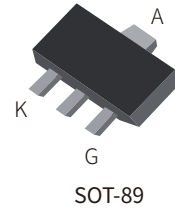

APPLICATIONS

- | Ignition circuits
- | Lighting ballasts
- | Protection circuits
- | Switched mode power supplies

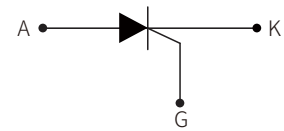

Schematic Symbol

ABSOLUTE MAXIMUM RATINGS

Parameter	Symbol	Value	Unit
Repetitive peak off-state voltage ($T_j=25^\circ\text{C}$)	$V_{\text{DRM}} / V_{\text{RRM}}$	600	V
RMS on-state current ($T_c \leq 60^\circ\text{C}$)	$I_{\text{T(RMS)}}$	0.8	A
Non repetitive surge peak on-state current ($t_p=20\text{ms}$)	I_{TSM}	8	
I ² t value for fusing ($t_p=10\text{ms}$)	I ² t	0.32	A ² S
Critical rate of rise of on-state current	di/dt	50	A/ μs
Peak gate current ($t_p=20\mu\text{s}$, $T_j=110^\circ\text{C}$)	I_{GM}	0.2	A
Average gate power dissipation ($T_j=125^\circ\text{C}$)	$P_{\text{G(AV)}}$	0.1	W
Average gate power dissipation ($T_j=110^\circ\text{C}$)	P_{GM}	0.5	W
Storage junction temperature range	T_{STG}	-40~+150	°C
Operating junction temperature range	T_j	-40~+125	

ELECTRICAL CHARACTERISTICS (T_j=25°C unless otherwise specified)

Symbol	Test Condition	Value			Unit
		Min.	Typ.	Max.	
I _{GT}	V _D =12V, R _L =33Ω	-	30	200	uA
V _{GT}		-	0.6	0.8	V
V _{GD}	V _D =V _{DRM} , T _J =110°C	0.2	-	-	
I _L	I _G =1.2I _{GT}	-	-	5	
I _H	I _T =0.05A	-	-	3	
dV _D /dt	V _D =67%V _{DRM} , T _J =125°C	10	-	-	V/μs

STATIC CHARACTERISTICS

Symbol	Parameter	Value	Unit
V _{TM}	I _T =1A, t _p =380μs, T _J =25°C	≤1.5	V
I _{DRM}	V _D =V _{DRM} , V _R =V _{RRM} , T _J =25°C	≤5	uA
I _{RRM}	V _D =V _{DRM} , V _R =V _{RRM} , T _J =110°C	≤100	

THERMAL RESISTANCES

Symbol	Parameter	Value	Unit
R _{th(j-c)}	Junction to case(AC)	75	°C/W

PARAMETER CHARACTERISTIC CURVE

FIG.1 Maximum power dissipation versus RMS on-state current

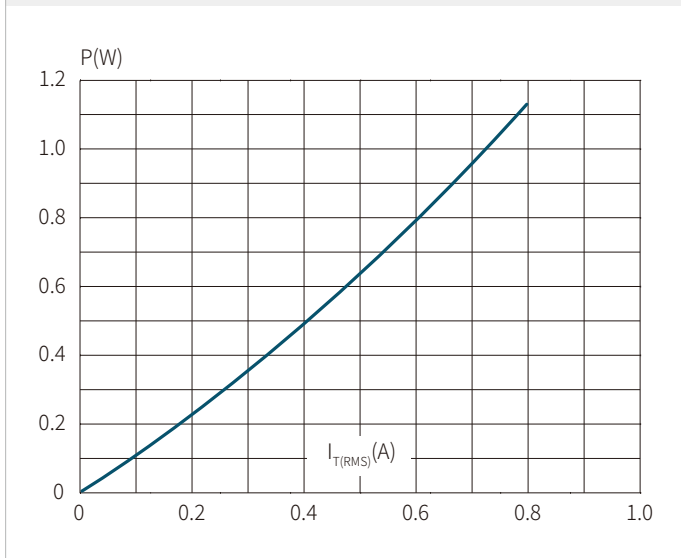

FIG.2 RMS on-state current versus case temperature

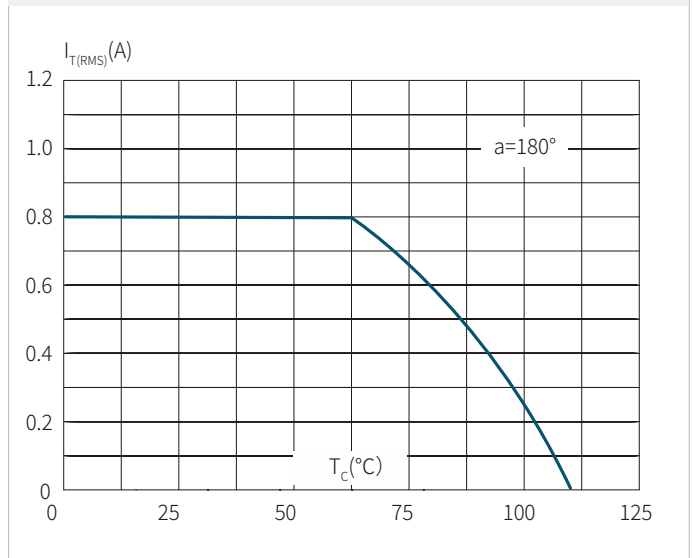

FIG.3 Surge peak on-state current versus number of cycles

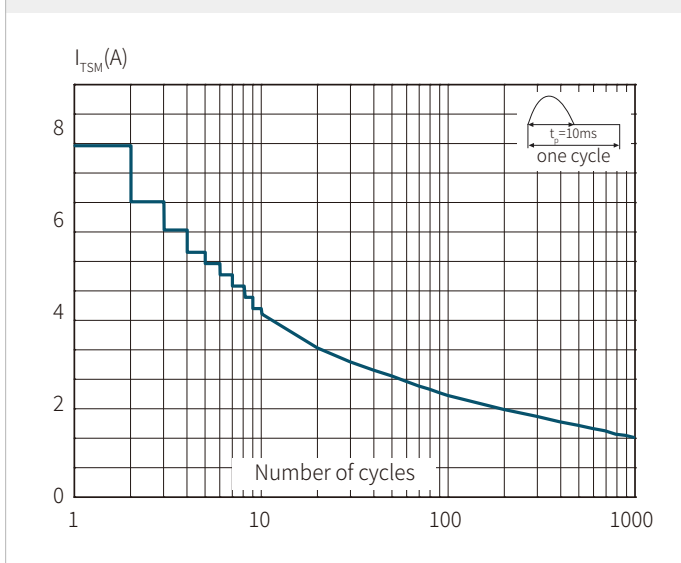

FIG.4 On-state characteristics (maximum values)

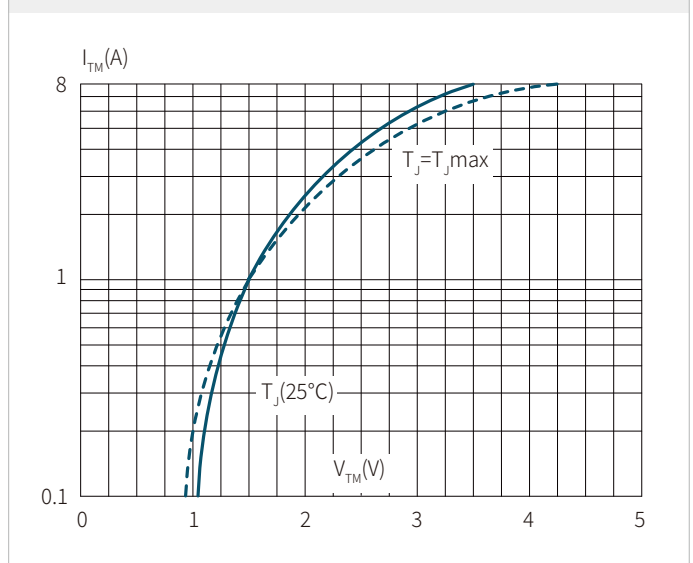

Fig.5 non-repetitive surge peak on-state current for a sinusoidal pulse with width $t_p < 10\text{ms}$, and corresponding value of I^2t

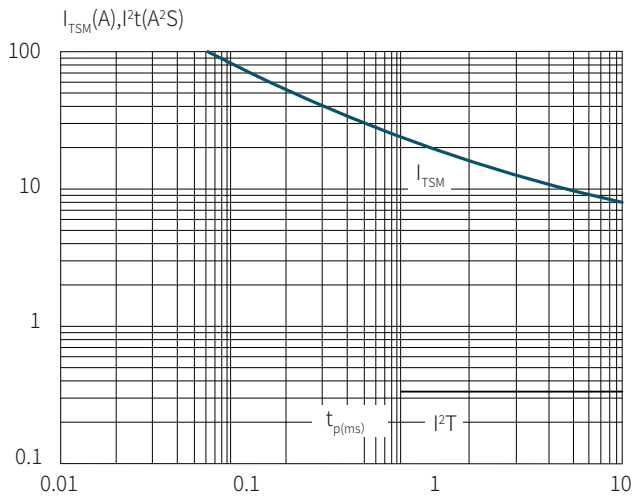

FIG.6 Relative variations of gate trigger current versus junction temperature

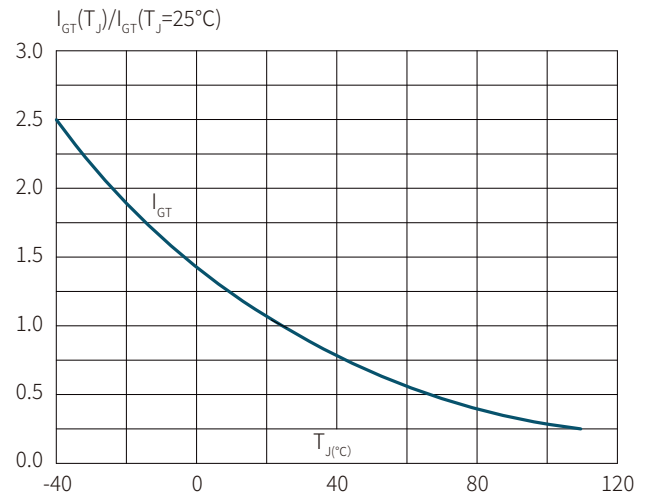

FIG.7 Relative variations of holding current versus junction temperature

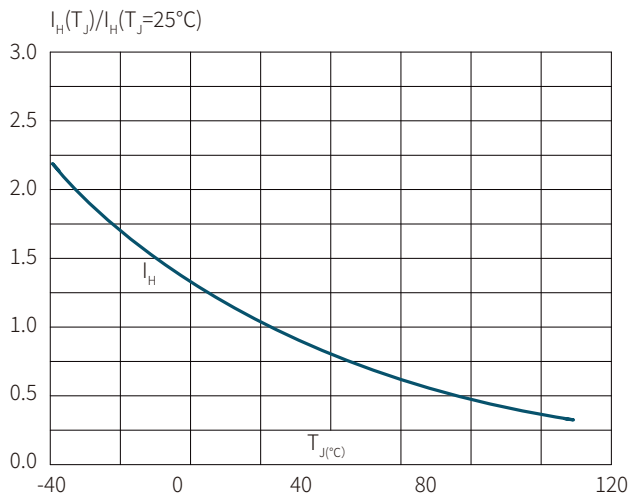
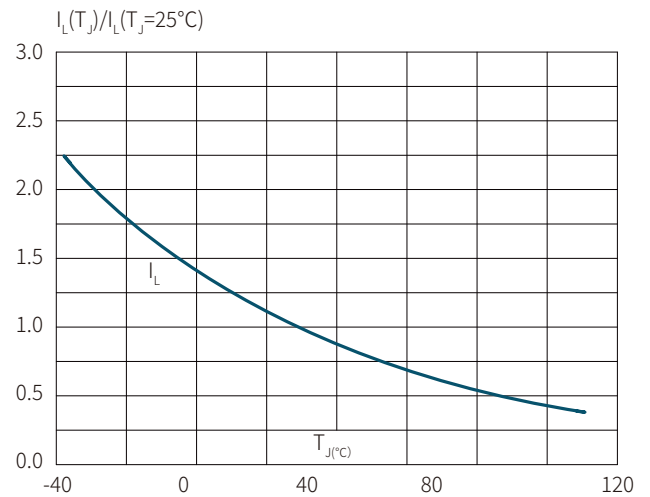
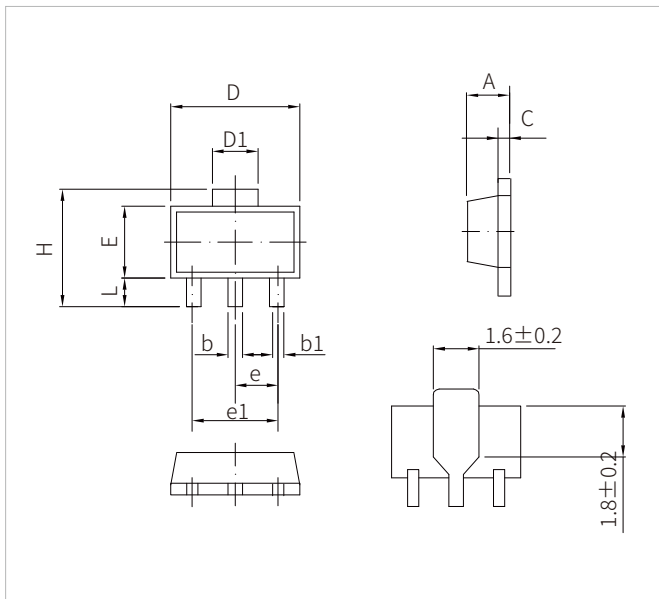

FIG.8 Relative variations of latching current versus junction temperature



SOT-89 PACKAGE MECHANICAL DATA



Ref.	Dimensions			
	Millimeters		Inches	
	Min.	Max.	Min.	Max.
A	1.30	1.70	0.051	0.067
b	0.40	0.60	0.016	0.024
b1	0.25	0.55	0.010	0.022
C	0.30	0.50	0.012	0.020
D	4.30	4.70	0.169	0.185
D1	1.40	1.80	0.055	0.071
E	2.30	2.70	0.091	0.106
e	1.5TYP		0.059TYP	
e1	2.90	3.10	0.114	0.122
H	3.90	4.40	0.154	0.173
L	0.80	1.20	0.031	0.047

ORDERING INFORMATION

Part Number	Size	QTY/Reel	Reel Size
MCK100-8	SOT-89	1000PCS	7"

To find your local partner within Semiwell' s website : www.semiwell.com.cn

© 2023 Semiwell Microelectronics Co.,Ltd.

The content of this document has been carefully checked and understood. However, neither Semiwell nor its subsidiaries assume any liability whatsoever for any errors or inaccuracies of this document and the consequences thereof. Published specifications are subject to change without notice. Product suitability for any area of application must ultimately be determined by the customer. In all cases, products must never be operated outside their published specifications. Semiwell does not guarantee the availability of all published products. This disclaimer shall be governed by substantive Chinese law and resulting disputes shall be settled by the courts at the place of business of Semiwell. Latest publications and a complete disclaimer can be downloaded from the Semiwell website. All trademarks recognized.