

FEATURES

- | Low profile package
- | Ideal for automated placement
- | 200 Watt peak pulse power capability with a 10/1000µs waveform
- | For surface mounted applications to optimize board space
- | Excellent clamping capability
- | Very fast response time
- | Low incremental surge resistance

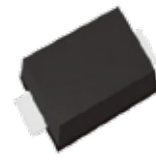

SOD-123FL

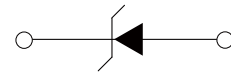

Uni-directional

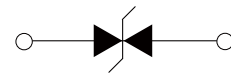

Bi-directional

APPLICATIONS

- | Power supply protection
- | Automotive application
- | Industrial application
- | Power management

APPROVALS

RoHS	Compliance with 2011/65/EU
HF	Compliance with IEC61249-2-21:2003

MAXIMUM RATINGS (T_A=25°C)

Parameter	Symbo	Value	Unit
Peak Pulse Power Dissipation on 10/1000us waveform (Note1)	P _{PPM}	200	Watts
Steady State Power Dissipation at T _L =75°C	P _D	0.4	Watts

Notes : 1.Non-repetitive current pulse,T_A=25°C.
 2.8.3ms single half sine-wave, or equivalent square wave, Duty cycle = 4 pulses per minutes maximum

THERMAL CONSIDERATIONS

Parameter	Symbol	Value	Unit
Operating Junction Temperature	T _J	-55 to +150	°C
Storage Temperature Range	T _{STG}	-55 to +150	°C
Junction to Ambient on printed circuit	R _{θJA}	220	°C/W

ELECTRICAL CHARACTERISTICS (T_A = 25°C)

Part Number		Device Marking Code		Reverse Stand-off Voltage	Breakdown Voltage Min.@I _T	Breakdown Voltage Max.@I _T	Test Current	Maximum Clamping Voltage @I _{PP}	Peak Pulse Current	Reverse Leakage @V _{RWM}
Uni-Polar	Bi-Polar	Uni	Bi	V _{RWM} (V)	V _{BR} (V)	V _{BR} (V)	I _T (mA)	V _C (V)	I _{PP} (A)	I _R (uA)
SMF3.3A	SMF3.3CA	HZ	GZ	3.3	5.2	6.00	10	8.0	25.0	800
SMF5.0A	SMF5.0CA	AE	FE	5.0	6.4	7.00	10	9.2	21.7	800
SMF6.0A	SMF6.0CA	AG	FG	6.0	6.67	7.37	10	10.3	19.4	800
SMF6.5A	SMF6.5CA	AK	FK	6.5	7.22	7.98	10	11.2	17.9	500
SMF7.0A	SMF7.0CA	AM	FM	7.0	7.78	8.60	10	12.0	16.7	200
SMF7.5A	SMF7.5CA	AP	FP	7.5	8.33	9.21	1	12.9	15.5	100
SMF8.0A	SMF8.0CA	AR	FR	8.0	8.89	9.83	1	13.6	14.7	50
SMF8.5A	SMF8.5CA	AT	FT	8.5	9.44	10.4	1	14.4	13.9	20
SMF9.0A	SMF9.0CA	AV	FV	9.0	10.0	11.1	1	15.4	13.0	10
SMF10A	SMF10CA	AX	FX	10.0	11.1	12.3	1	17.0	11.8	5
SMF11A	SMF11CA	AZ	FZ	11.0	12.2	13.5	1	18.2	11.0	1
SMF12A	SMF12CA	BE	GE	12.0	13.3	14.7	1	19.9	10.1	1
SMF13A	SMF13CA	BG	GG	13.0	14.4	15.9	1	21.5	9.3	1
SMF14A	SMF14CA	BK	GK	14.0	15.6	17.2	1	23.2	8.6	1
SMF15A	SMF15CA	BM	GM	15.0	16.7	18.5	1	24.4	8.2	1
SMF16A	SMF16CA	BP	GP	16.0	17.8	19.7	1	26.0	7.7	1
SMF17A	SMF17CA	BR	GR	17.0	18.9	20.9	1	27.6	7.2	1
SMF18A	SMF18CA	BT	GT	18.0	20.0	22.1	1	29.2	6.8	1
SMF20A	SMF20CA	BV	GV	20.0	22.2	24.5	1	32.4	6.2	1
SMF22A	SMF22CA	BX	GX	22.0	24.4	26.9	1	35.5	5.6	1
SMF24A	SMF24CA	BZ	GZ	24.0	26.7	29.5	1	38.9	5.1	1
SMF26A	SMF26CA	CE	HE	26.0	28.9	31.9	1	42.1	4.8	1
SMF28A	SMF28CA	CG	HG	28.0	31.1	34.4	1	45.4	4.4	1
SMF30A	SMF30CA	CK	HK	30.0	33.3	36.8	1	48.4	4.1	1
SMF33A	SMF33CA	CM	HM	33.0	36.7	40.6	1	53.3	3.8	1
SMF36A	SMF36CA	CP	HP	36.0	40.0	44.2	1	58.1	3.4	1
SMF40A	SMF40CA	CR	HR	40.0	44.4	49.1	1	64.5	3.1	1
SMF43A	SMF43CA	CT	HT	43.0	47.8	52.8	1	69.4	2.9	1
SMF45A	SMF45CA	CV	HV	45.0	50.0	55.3	1	72.7	2.8	1

Part Number		Device Marking Code		Reverse Stand-off Voltage	Breakdown Voltage Min.@I _T	Breakdown Voltage Max.@I _T	Test Current	Maximum Clamping Voltage @I _{pp}	Peak Pulse Current	Reverse Leakage @V _{RWM}
Uni-Polar	Bi-Polar	Uni	Bi	V _{RWM} (V)	V _{BR} (V)	V _{BR} (V)	I _T (mA)	V _C (V)	I _{PP} (A)	I _R (μA)
SMF48A	SMF48CA	CX	HX	48.0	53.3	58.9	1	77.4	2.6	1
SMF51A	SMF51CA	CZ	HZ	51.0	56.7	62.7	1	82.4	2.4	1
SMF54A	SMF54CA	DE	IE	54.0	60.0	66.3	1	87.1	2.3	1
SMF58A	SMF58CA	DG	IG	58.0	64.4	71.2	1	93.6	2.1	1
SMF60A	SMF60CA	DK	IK	60.0	66.7	73.7	1	96.8	1.86	1
SMF64A	SMF64CA	DM	IM	64.0	71.1	78.6	1	103.0	1.75	1
SMF70A	SMF70CA	DP	IP	70.0	77.8	86.0	1	113.0	1.59	1
SMF75A	SMF75CA	DR	IR	75.0	83.3	92.1	1	121.0	1.49	1
SMF78A	SMF78CA	DT	IT	78.0	86.7	95.8	1	126.0	1.43	1
SMF85A	SMF85CA	DV	IV	85.0	94.4	104.0	1	137.0	1.31	1
SMF90A	SMF90CA	DX	IX	90.0	100.0	111.0	1	146.0	1.23	1
SMF100A	SMF100CA	EZ	JZ	100.0	111.0	123.0	1	162.0	1.11	1
SMF110A	SMF110CA	EE	JE	110.0	122.0	135.0	1	177.0	1.02	1
SMF120A	SMF120CA	EG	JG	120.0	133.0	147.0	1	193.0	0.93	1
SMF130A	SMF130CA	EK	JK	130.0	144.0	159.0	1	209.0	0.86	1
SMF150A	SMF150CA	EM	JM	150.0	167.0	185.0	1	243.0	0.74	1
SMF160A	SMF160CA	EP	JP	160.0	178.0	197.0	1	259.0	0.69	1
SMF170A	SMF170CA	ER	JR	170.0	189.0	209.0	1	275.0	0.65	1
SMF180A	SMF180CA	ET	JT	180.0	201.0	222.0	1	292.0	0.66	1
SMF190A	SMF190CA	EU	JU	190.0	209.0	243.0	1	308.0	0.63	1
SMF200A	SMF200CA	EV	JV	200.0	224.0	247.0	1	324.0	0.59	1
SMF210A	SMF210CA	EW	JW	210.0	231.0	269.0	1	340.0	0.57	1
SMF220A	SMF220CA	EY	JY	220.0	246.0	272.0	1	356.0	0.54	1

CHARACTERISTIC CURVES

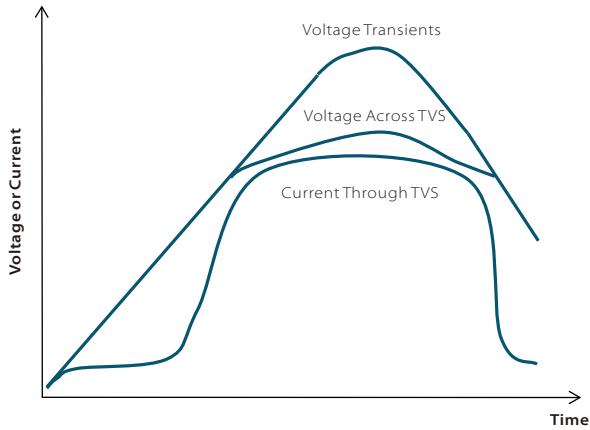
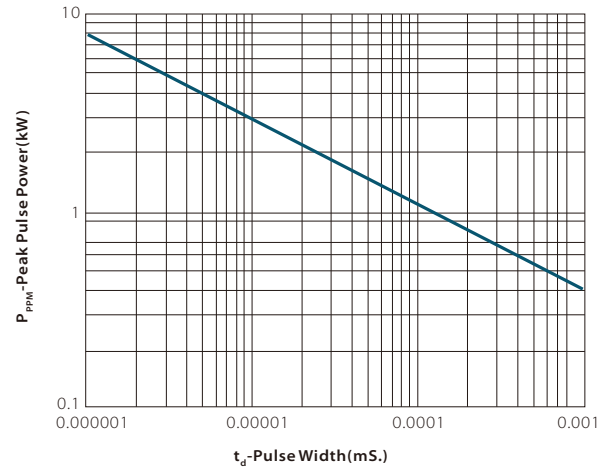
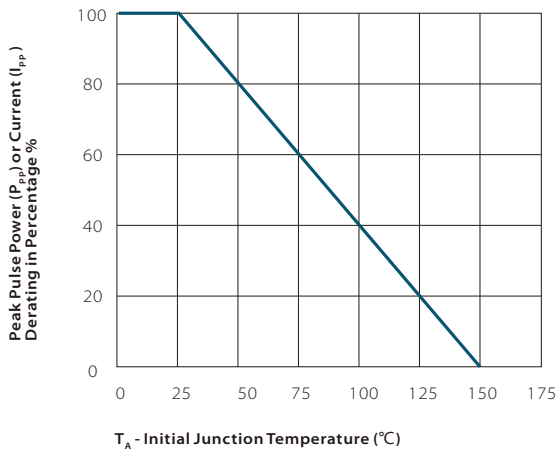
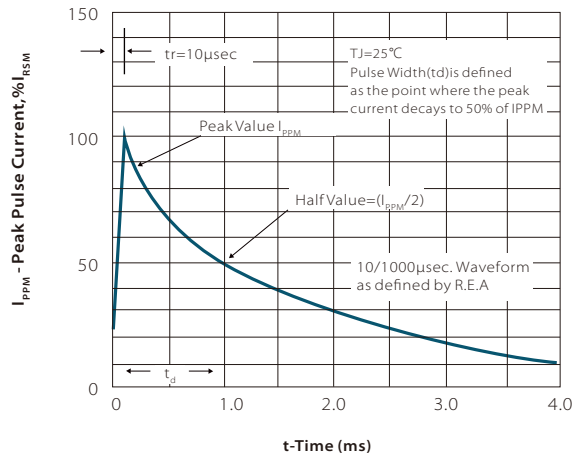
TVS Transients Clamping Waveform

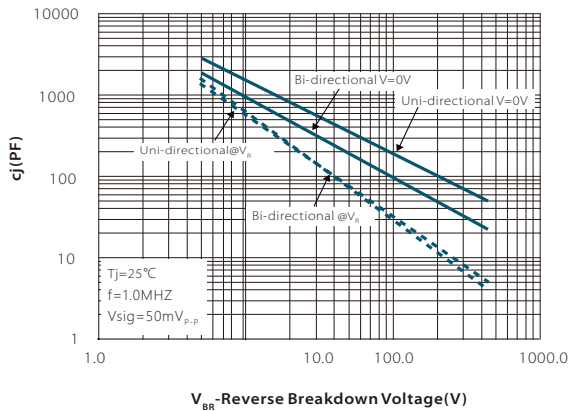
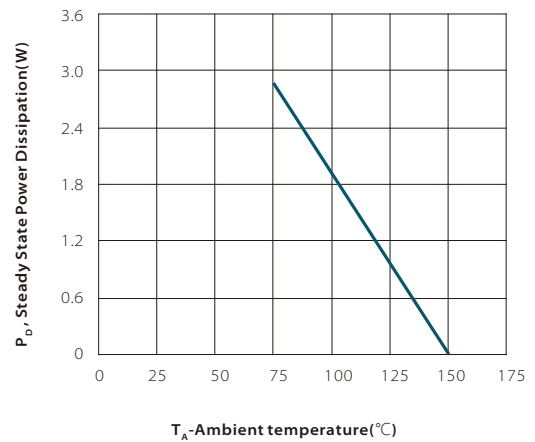
Peak Pulse Power Rating Curve

Pulse Derating Curve

Pulse Waveform

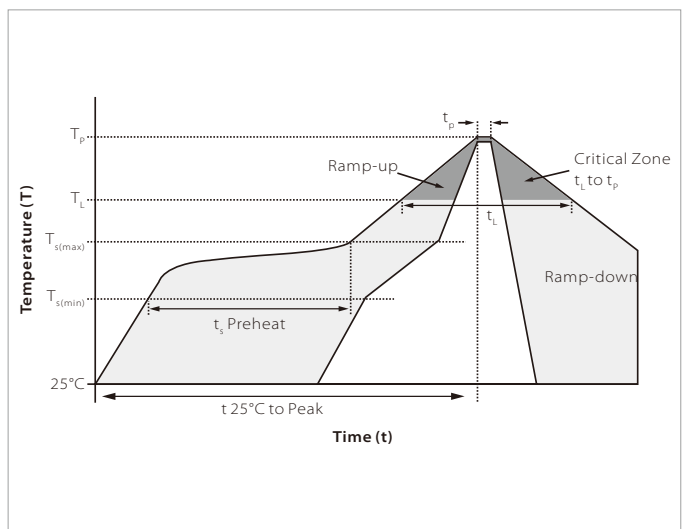
Typical Junction Capacitance

Steady State Power Dissipation Derating Curve

SOLDERING PARAMETERS

Reflow Condition		Lead-free assembly
Pre Heat	Temperature Max ($T_{s(min)}$)	150°C
	Temperature Max ($T_{s(max)}$)	200°C
	Time (min to max) (t_s)	60 – 180 secs
Average ramp up rate (Liquidus Temp (T_L) to peak)		3°C/second max
$T_{s(max)}$ to T_L - Ramp-up Rate		3°C/second max
Reflow	Temperature (T_L) (Liquidus)	217°C
	Time (min to max) (t_r)	60 – 150 seconds
Peak Temperature (T_p)		260°C
Time within 5°C of actual peak Temperature (t_p)		20 – 40 seconds
Ramp-down Rate		6°C/second max
Time 25°C to peak Temperature (T_p)		8 minutes max.
Do not exceed		260°C

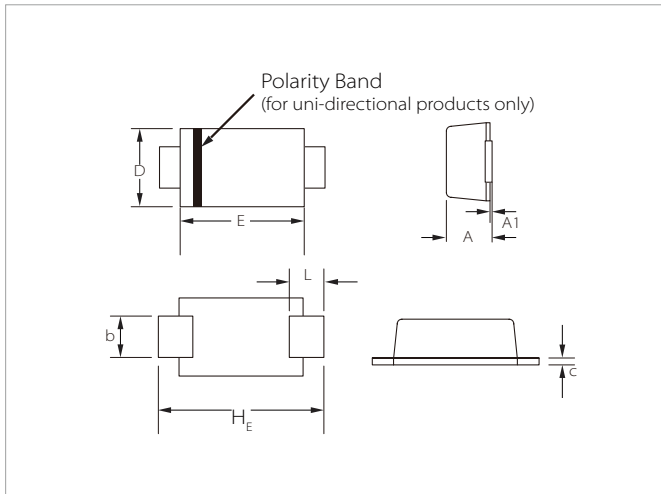

SOD-123FL PACKAGE INFORMATION



Ref.	Millimeters		Inches	
	Min.	Max.	Min.	Max.
A	0.95	1.45	0.037	0.057
A1	0.00	0.10	0.000	0.004
b	0.70	1.20	0.028	0.047
c	0.05	0.30	0.002	0.012
D	1.50	2.00	0.059	0.079
E	2.50	2.90	0.098	0.114
L	0.35	0.90	0.014	0.035
H _E	3.40	3.90	0.134	0.154

RECOMMENDED PAD LAYOUT DIMENSIONS

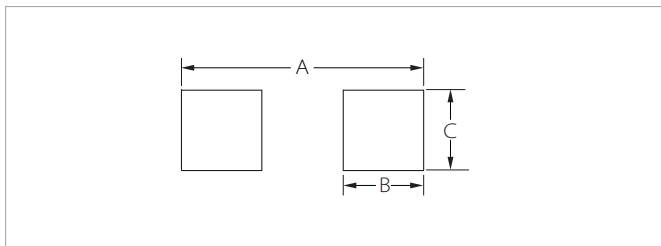

Ref.	Millimeters	Inches
A	4.20	0.165
B	1.50	0.059
C	1.20	0.047

ORDERING INFORMATION

Part Number	Component Package	QTY/Reel	Reel Size
SMFxx(C)A	SOD-123FL	3000PCS	7"

To find your local partner within Semiwell's website : www.semiwell.com.cn

©2023 Semiwell Microelectronics Co.,Ltd.

The content of this document has been carefully checked and understood. However, neither Semiwell nor its subsidiaries assume any liability whatsoever for any errors or inaccuracies of this document and the consequences thereof. Published specifications are subject to change without notice. Product suitability for any area of application must ultimately be determined by the customer. In all cases, products must never be operated outside their published specifications. Semiwell does not guarantee the availability of all published products. This disclaimer shall be governed by substantive Chinese law and resulting disputes shall be settled by the courts at the place of business of Semiwell. Latest publications and a complete disclaimer can be downloaded from the Semiwell website. All trademarks recognized.