

## FEATURES

- | High Density Cell Design For Low  $R_{DS(on)}$
- | Voltage Controlled Small Signal Switch
- | Rugged and Reliable
- | High Saturation Current Capability
- | Lead free product is acquired

## APPLICATION

- | Direct logic-level interface: TTL/CMOS
- | Drivers: relays, solenoids, lamps
- | hammers, display, memories, etc.
- | Battery operated systems
- | Solid-state relays

## APPROVALS

<b>RoHS</b>	Compliance with 2011/65/EU
<b>HF</b>	Compliance with IEC61249-2-21:2003

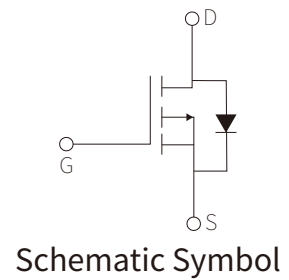

## ABSOLUTE MAXIMUM RATINGS ( $T_A=25^\circ\text{C}$ unless otherwise noted)

Parameter	Symbol	Value	Unit
Drain-Source Voltage	$V_{DS}$	-20	V
Maximum Drain Current - Continuous	$I_D$	-3	A
Gate-Source Voltage	$V_{GS}$	$\pm 12$	V
Maximum Power Dissipation	$P_D$	1	W
Thermal Resistance from Junction to Ambient	$R_{\theta JA}$	125	$^\circ\text{C}/\text{W}$
Junction Temperature	$T_J$	-55 to 150	$^\circ\text{C}$
Storage Temperature Range	$T_{STG}$	-55 to 150	$^\circ\text{C}$

## ELECTRICAL CHARACTERISTICS (T<sub>A</sub> = 25°C unless otherwise noted)

Parameter	Symbol	Test Conditions	Min	Typ	Max	Unit
<b>Off Characteristics</b>						
Drain-source Breakdown Voltage	V <sub>(BR)DSS</sub>	V <sub>GS</sub> =0V, I <sub>D</sub> =-250μA	-20	-24		V
Zero gate voltage drain current	I <sub>DSS</sub>	V <sub>DS</sub> =-20V, V <sub>GS</sub> =0V			-1	uA
Gate-body leakage current	I <sub>GSS1</sub>	V <sub>GS</sub> =±12V, V <sub>DS</sub> =0V			±100	nA
<b>On Characteristics<sup>(Note 3)</sup></b>						
Gate threshold voltage	V <sub>GS(th)</sub>	V <sub>DS</sub> =V <sub>GS</sub> , I <sub>D</sub> =-250μA	-0.4	-0.7	-1	V
Drain-source on-resistance	R <sub>DS(on)</sub>	V <sub>GS</sub> =-4.5V, I <sub>D</sub> =-3A		64	110	mΩ
		V <sub>GS</sub> =-2.5V, I <sub>D</sub> =-2A		89	140	mΩ
Forward Transconductance	g <sub>FS</sub>	V <sub>DS</sub> =-5V, I <sub>D</sub> =-2A	5			S
<b>Dynamic Characteristics<sup>(Note4)</sup></b>						
Input capacitance	C <sub>iss</sub>	V <sub>DS</sub> =-10V, V <sub>GS</sub> =0V, f=1MHz		405		pF
Output capacitance	C <sub>oss</sub>			75		pF
Reverse transfer capacitance	C <sub>rss</sub>			55		pF
<b>Switching Characteristics<sup>(Note4)</sup></b>						
Turn-on Delay Time	t <sub>d(on)</sub>	V <sub>DD</sub> =10V, I <sub>D</sub> =-1A V <sub>GS</sub> =-4.5V, R <sub>GEN</sub> =10Ω		11		nS
Turn-on Rise Time	t <sub>r</sub>			35		nS
Turn-Off Delay Time	t <sub>d(off)</sub>			30		nS
Turn-Off Fall Time	t <sub>f</sub>			10		nS
Total Gate Charge	Q <sub>g</sub>	V <sub>DS</sub> =-10V, I <sub>D</sub> =-3A		3.3	12	nC
Gate-Source Charge	Q <sub>gs</sub>			0.7		nC
Gate-Drain Charge	Q <sub>gd</sub>			1.3		nC
<b>Drain-Source Diode Characteristics</b>						
Diode Forward Voltage <sup>(Note 3)</sup>	V <sub>SD</sub>	V <sub>GS</sub> =0V, I <sub>S</sub> =1.3A			-1.2	V
Diode Forward Current <sup>(Note 2)</sup>	I <sub>S</sub>				-3	A

**Notes:**

1. Repetitive Rating: Pulse width limited by maximum junction temperature.
2. Surface Mounted on FR4 Board, t ≤ 10 sec.
3. Pulse Test: Pulse Width ≤ 300μs, Duty Cycle ≤ 2%.
4. Guaranteed by design, not subject to production

# PARAMETER CHARACTERISTIC CURVE

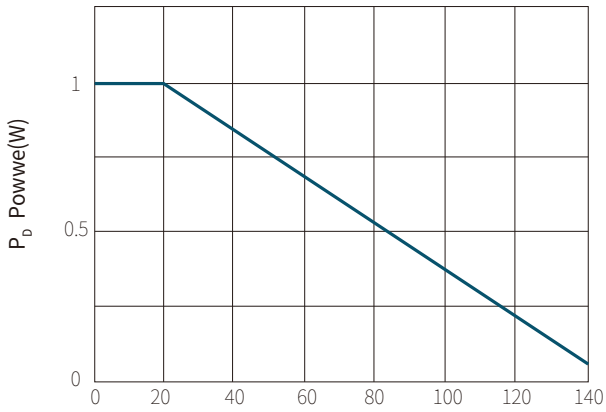
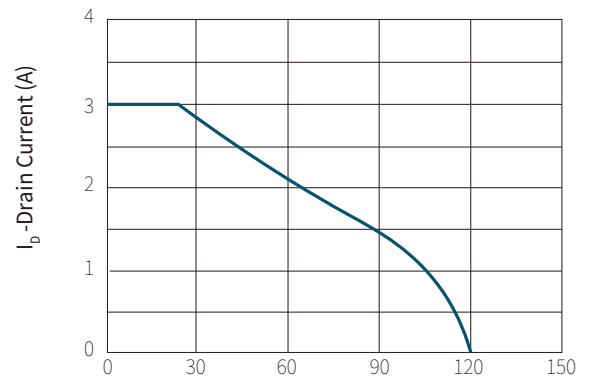
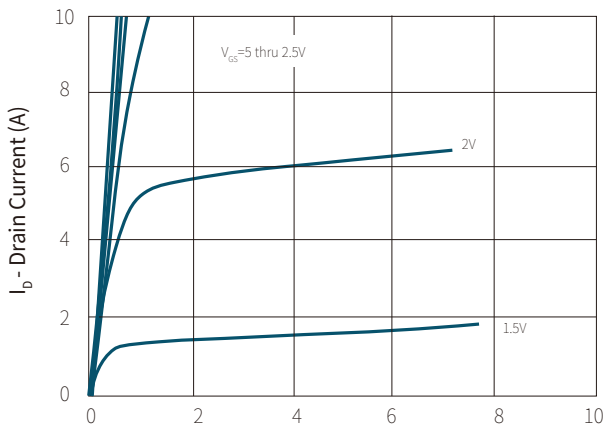
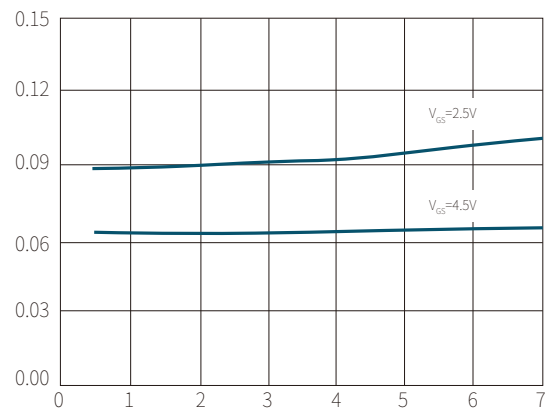
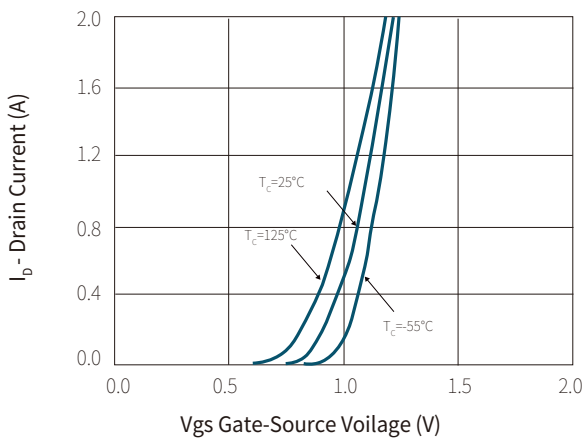
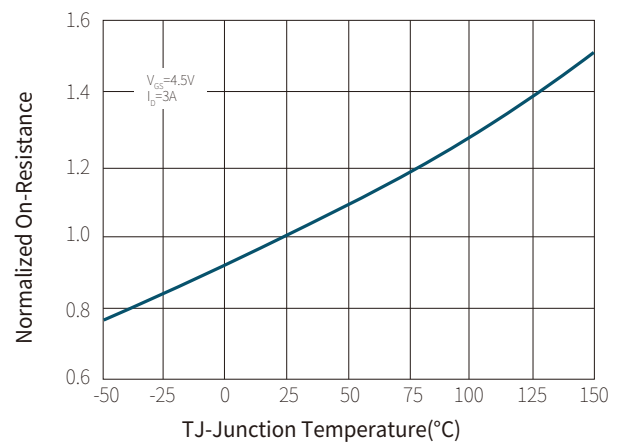
**Figure 1: Power Dissipation**

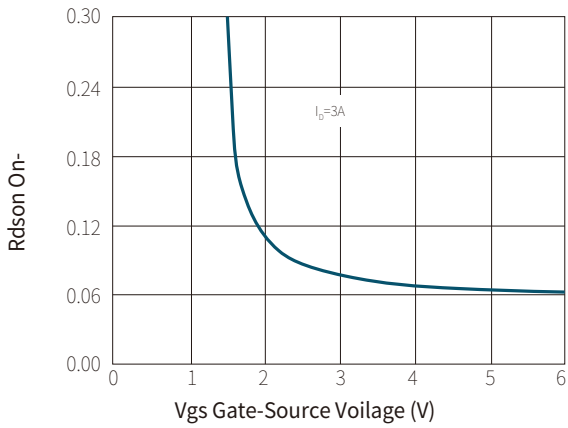
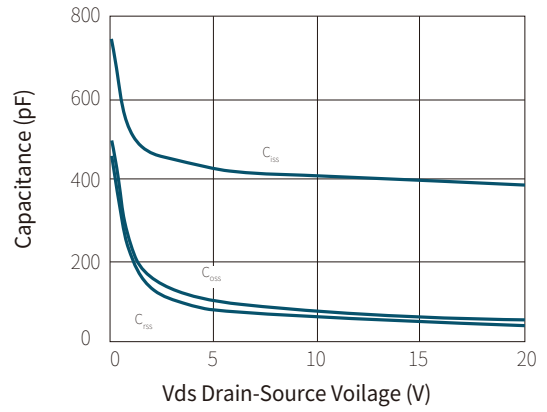
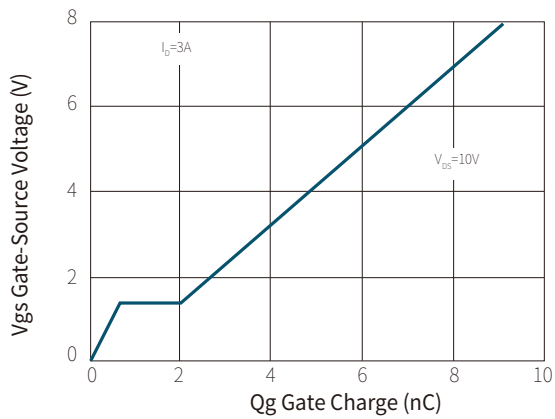
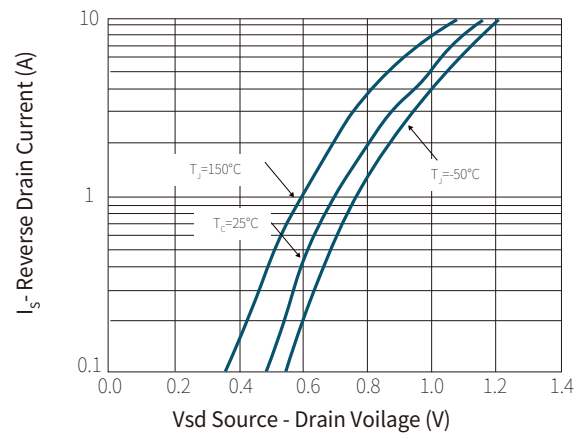
**Figure 2: Drain Current**

**Figure 3: Output Characteristics**

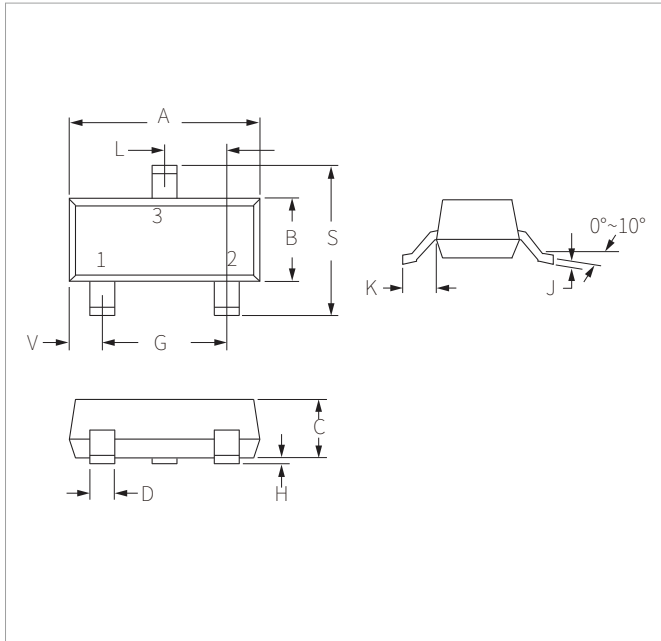
**Figure 4: Drain-Source On-Resistance**

**Figure 5: Transfer Characteristics**

**Figure 6: Drain-Source On-Resistance**

**Figure 7: Rdson vs Vgs**

**Figure 8: Capacitance vs Vds**

**Figure 9: Gate Charge**

**Figure 10: Source- Drain Diode Forward**

## SOT-23 PACKAGE INFORMATION

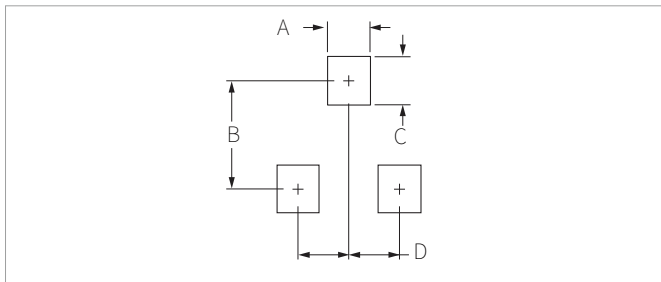

Ref.	Millimeters		Inches	
	Min	Max	Min	Max
A	2.80	3.04	0.110	0.120
B	1.20	1.40	0.047	0.055
C	0.89	1.11	0.035	0.044
D	0.37	0.50	0.015	0.020
G	1.78	2.04	0.070	0.081
H	0.01	0.100	0.001	0.004
J	0.085	0.180	0.003	0.007
K	0.35	0.69	0.014	0.029
L	0.89	1.02	0.035	0.040
S	2.10	2.64	0.083	0.104
V	0.45	0.60	0.018	0.024

## RECOMMENDED PAD LAYOUT DIMENSIONS



Ref.	Millimeters		Inches	
	Min	Max	Min	Max
A	0.71	0.97	0.028	0.038
B	1.88	2.13	0.074	0.084
C	0.71	0.97	0.028	0.038
D	0.81	1.07	0.032	0.042

## ORDERING INFORMATION

Part Number	Component Package	QTY/Reel	Reel Size
A03401C	SOT-23	3000PCS	7"

To find your local partner within Semiwell' s website : [www.semiwell.com.cn](http://www.semiwell.com.cn)

© 2023 Semiwell Microelectronics Co.,Ltd.

The content of this document has been carefully checked and understood. However, neither Semiwell nor its subsidiaries assume any liability whatsoever for any errors or inaccuracies of this document and the consequences thereof. Published specifications are subject to change without notice. Product suitability for any area of application must ultimately be determined by the customer. In all cases, products must never be operated outside their published specifications. Semiwell does not guarantee the availability of all published products. This disclaimer shall be governed by substantive Chinese law and resulting disputes shall be settled by the courts at the place of business of Semiwell. Latest publications and a complete disclaimer can be downloaded from the Semiwell website. All trademarks recognized.