

## FEATURES

| High Collector Current

| Complementary To S9013

| Excellent  $h_{FE}$  Linearity



SOT-23

## MECHANICAL DATA

| SOT-23 small outline plastic package

| Epoxy UL: 94V-0

| Mounting position: Any

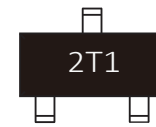

Marking

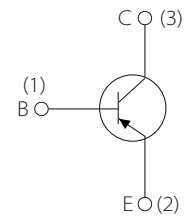

Schematic Symbol

## APPROVALS

<b>RoHS</b>	Compliance with 2011/65/EU
<b>HF</b>	Compliance with IEC61249-2-21:2003

## MAXIMUM RATINGS ( $T_A=25^{\circ}\text{C}$ )

Parameter	Symbol	Value	Unit
Collector-Base Voltage	$V_{CBO}$	-40	V
Collector-Emitter Voltage	$V_{CEO}$	-25	
Emitter-Base Voltage	$V_{EBO}$	-5	
Collector Current	$I_C$	-500	mA
Collector Power Dissipation	$P_C$	300	mW
Thermal Resistance From Junction To Ambient	$R_{\theta JA}$	416	$^{\circ}\text{C}/\text{W}$
Junction Temperature	$T_J$	-55~+150	$^{\circ}\text{C}$
Storage Temperature	$T_{STG}$	-55~+150	$^{\circ}\text{C}$

## ELECTRICAL CHARACTERISTICS (T<sub>A</sub>=25°C)

Parameter	Symbol	Test Conditions	Min.	Typ.	Max.	Unit
Collector-base breakdown voltage	V <sub>(BR)CBO</sub>	I <sub>C</sub> =-0.1mA, I <sub>E</sub> =0	-40			V
Collector-emitter breakdown voltage	V <sub>(BR)CEO</sub>	I <sub>C</sub> =-1mA, I <sub>B</sub> =0	-25			
Emitter-base breakdown voltage	V <sub>(BR)EBO</sub>	I <sub>E</sub> =-0.1mA, I <sub>C</sub> =0	-5			
Collector cut-off current	I <sub>CEO</sub>	V <sub>CE</sub> =-20V, I <sub>B</sub> =0			-0.1	uA
Emitter cut-off current	I <sub>CBO</sub>	V <sub>CB</sub> =-40V, I <sub>E</sub> =0			-0.1	
Emitter cut-off current	I <sub>EBO</sub>	V <sub>EB</sub> =-5V, I <sub>C</sub> =0			-0.1	
DC current gain	h <sub>FE</sub>	V <sub>CE</sub> =-1V, I <sub>C</sub> =-50mA	120		400	
Collector-emitter saturation voltage	V <sub>CE(sat)</sub>	I <sub>C</sub> =-500mA, I <sub>B</sub> =-50mA			-0.6	V
Base-emitter saturation voltage	V <sub>BE(sat)</sub>	I <sub>C</sub> =-500mA, I <sub>B</sub> =-50mA			-1.2	
Transition frequency	f <sub>T</sub>	V <sub>CE</sub> =-6V, I <sub>C</sub> =-20mA, f=30MHz	150			MHz
Collector output capacitance	C <sub>ob</sub>	V <sub>CB</sub> =-10V, I <sub>E</sub> =0, f=1MHz			5	pF

## CLASSIFICATION OF H<sub>FE(1)</sub>

Rank	L	H	J
Range	120-200	200-350	300-400

# TYPICAL CHARACTERISTICS

**Static Characteristic**

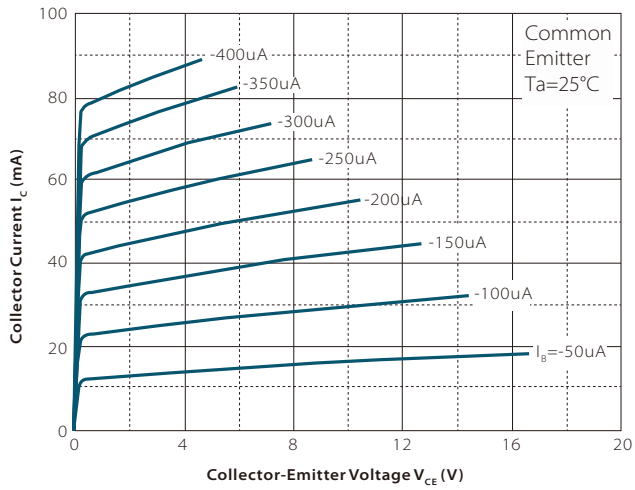

**$h_{FE}$  —  $I_C$**

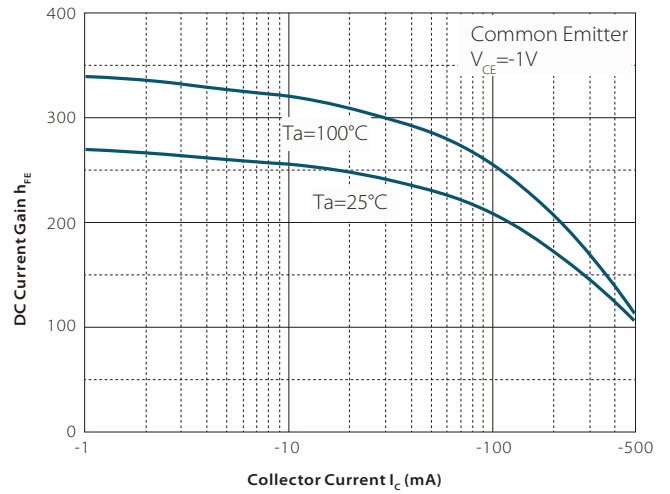

**$V_{CE sat}$  —  $I_C$**

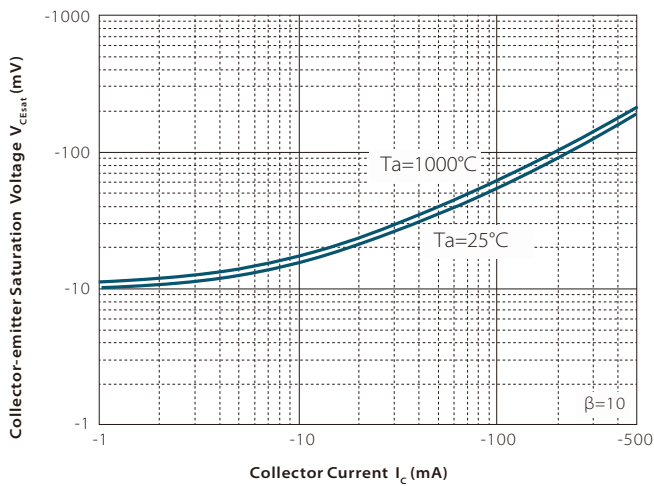

**$V_{BE sat}$  —  $I_C$**

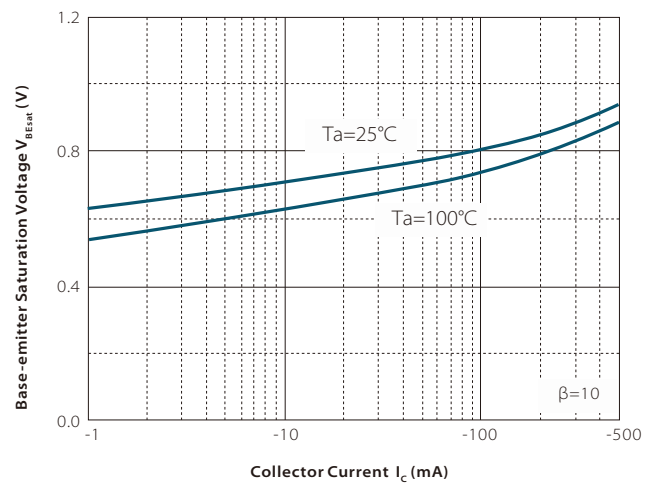

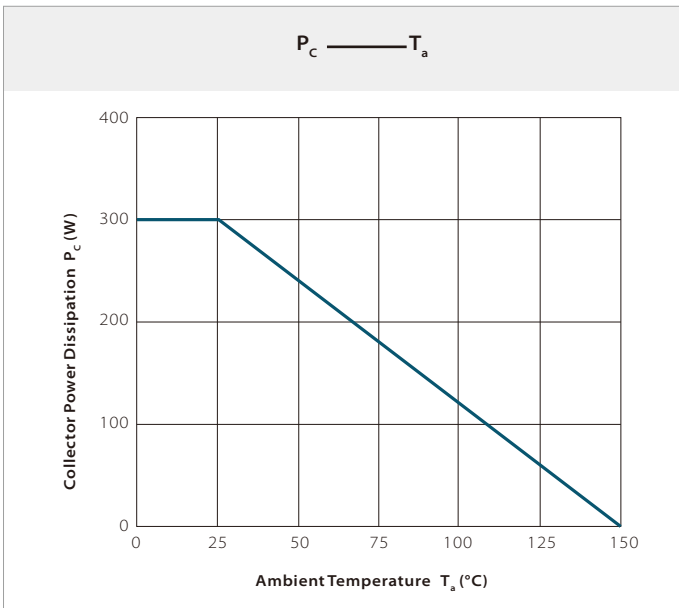
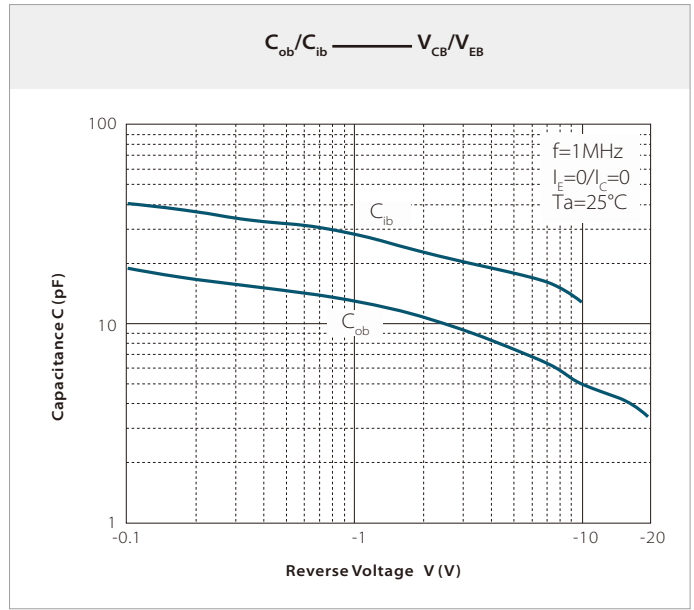
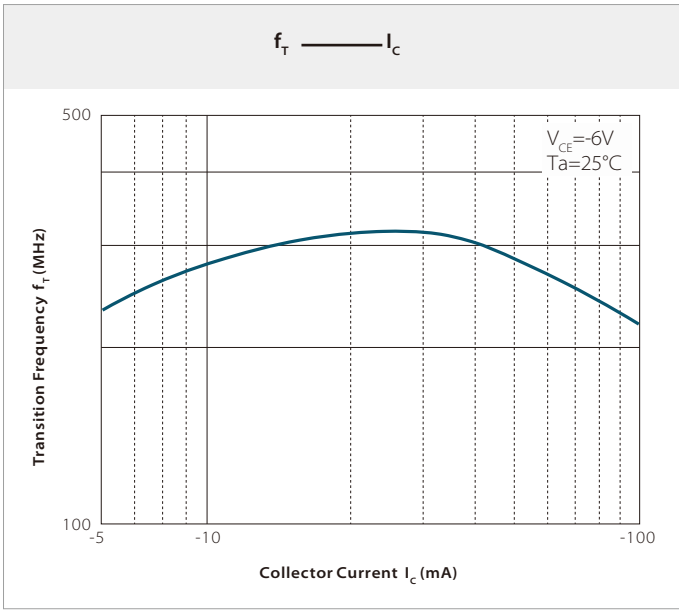

## SOLDERING PARAMETERS

Reflow Condition		Lead-free assembly
Pre Heat	Temperature Max ( $T_{s(min)}$ )	150°C
	Temperature Max ( $T_{s(max)}$ )	200°C
	Time (min to max) ( $t_s$ )	60 – 180 secs
Average ramp up rate (Liquidus Temp ( $T_L$ ) to peak)		3°C/second max
$T_{s(max)}$ to $T_L$ - Ramp-up Rate		3°C/second max
Reflow	Temperature ( $T_L$ ) (Liquidus)	217°C
	Time (min to max) ( $t_L$ )	60 – 150 seconds
Peak Temperature ( $T_p$ )		260°C
Time within 5°C of actual peak Temperature ( $t_p$ )		20 – 40 seconds
Ramp-down Rate		6°C/second max
Time 25°C to peak Temperature ( $T_p$ )		8 minutes max.
Do not exceed		260°C

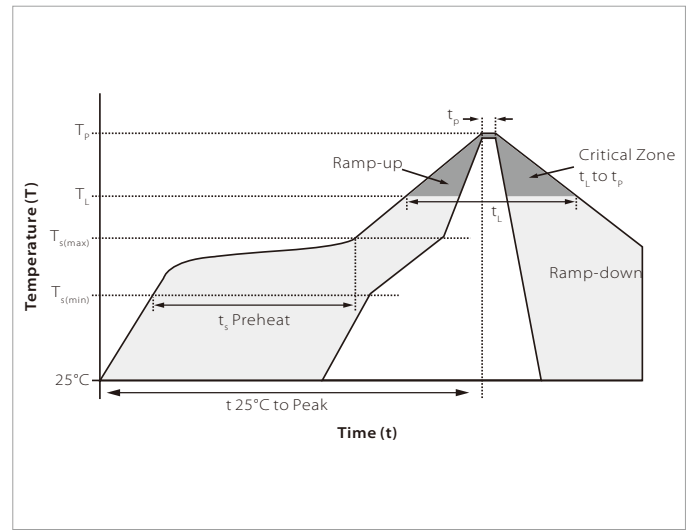

## SOT-23 PACKAGE INFORMATION

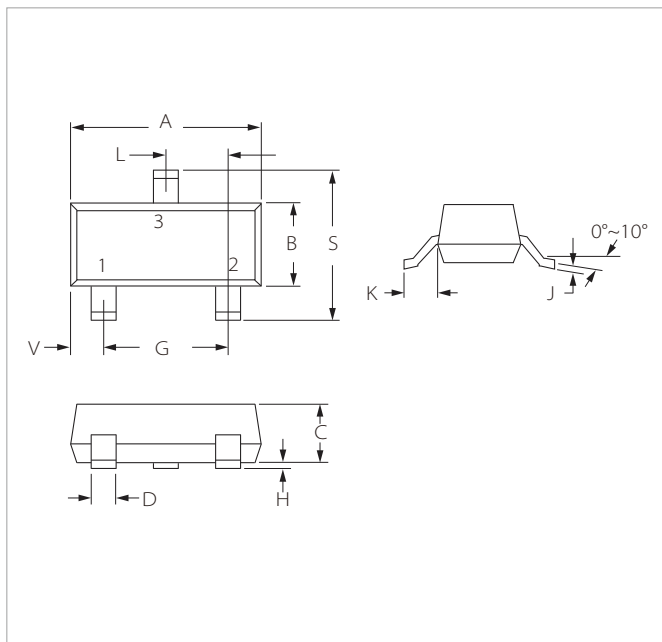

Ref.	Millimeters		Inches	
	Min.	Max.	Min.	Max.
A	2.80	3.04	0.110	0.120
B	1.20	1.40	0.047	0.055
C	0.89	1.11	0.035	0.044
D	0.37	0.50	0.015	0.020
G	1.78	2.04	0.070	0.081
H	0.01	0.100	0.001	0.004
J	0.085	0.180	0.003	0.007
K	0.35	0.69	0.014	0.029
L	0.89	1.02	0.035	0.040
S	2.10	2.64	0.083	0.104
V	0.45	0.60	0.018	0.024

## RECOMMENDED PAD LAYOUT DIMENSIONS

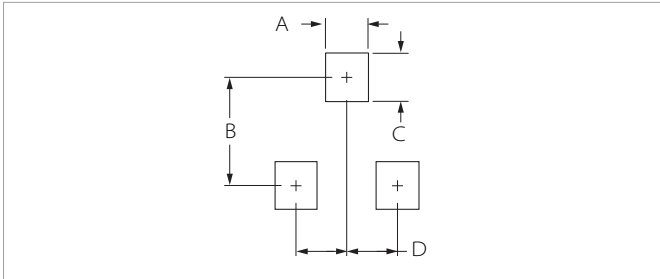

Ref.	Millimeters		Inches	
	Min.	Max.	Min.	Max.
A	0.71	0.97	0.028	0.038
B	1.88	2.13	0.074	0.084
C	0.71	0.97	0.028	0.038
D	0.81	1.07	0.032	0.042

## ORDERING INFORMATION

Part Number	Component Package	QTY/Reel	Reel Size
S9012	SOT-23	3000PCS	7"

To find your local partner within Semiwell's website : [www.semiwell.com.cn](http://www.semiwell.com.cn)

©2023 Semiwell Microelectronics Co.,Ltd.

The content of this document has been carefully checked and understood. However, neither Semiwell nor its subsidiaries assume any liability whatsoever for any errors or inaccuracies of this document and the consequences thereof. Published specifications are subject to change without notice. Product suitability for any area of application must ultimately be determined by the customer. In all cases, products must never be operated outside their published specifications. Semiwell does not guarantee the availability of all published products. This disclaimer shall be governed by substantive Chinese law and resulting disputes shall be settled by the courts at the place of business of Semiwell. Latest publications and a complete disclaimer can be downloaded from the Semiwell website. All trademarks recognized.